



TFE



TFA



TFT



TFP



TFN



TFM



TFF



TFS

CARACTERÍSTICAS

- Funcionamiento interferencia mecánica entre rosca y hormigón.
- Empleo para cargas altas. Alta resistencia al fuego.
- Homologado para 2 profundidades de instalación y hasta 3 para el Ø10.
- Uso para hormigón fisurado y no fisurado.
- Cumple con la guía VdS CEA 4001:2021-01(07) "Guidelines for sprinklers systems. Planning and installation"
- Adecuado cuando se tienen distancias entre anclajes o al borde reducidas.
- Empleo para cargas estáticas o cuasi-estáticas y cargas sísmicas C1&C2.
- Fácil instalación.
- Instalación directa a través del propio taladro de la placa de anclaje.
- Necesario taladro previo; la rosca en el material base se crea durante la instalación del anclaje.
- Reutilizable
- Puede ser desmontado, dejando la superficie diáfana.
- Variedad de longitudes y métricas, flexibilidad en el montaje
- VdS disponible desde Ø8 hasta Ø18
- Disponible en INDEXcal

APLICACIONES

- Fijaciones estructurales en hormigón fisurado y no fisurado en interior
- Acristalamientos, ventanas y escaparates
- Estanterías y racks
- Instalación de barandillas y pasamanos en interiores
- Fijación de estructuras de madera a hormigón.

HOMOLOGACIONES



MATERIAL BASE



RANGO DE MEDIDAS

Ø5 - Ø18

CONDICIÓN DE TALADRO

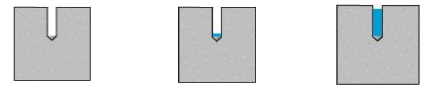

SECO HUMEDO INUNDADO





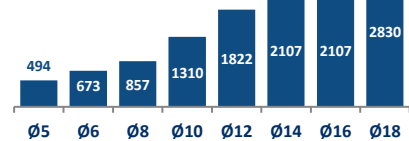











CARGAS MÁXIMAS RECOMENDADAS A TRACCIÓN EN HORMIGÓN NO FISURADO [kg]

TH/TF



EJEMPLOS DE APLICACIÓN



1. GAMA						
ITEM	CÓDIGO	MED.	FOTO	DESCRIPCION	MATERIAL	RECUBRIMIENTO
1	TFE	Ø5 - Ø18		Cabeza hexagonal con arandela estampada	Acero al carbono estampado, recubrimiento cincado $\geq 5 \mu\text{m}$	
2	TFA	Ø5 - Ø10		Cabeza avellanada	Acero al carbono estampado, recubrimiento cincado $\geq 5 \mu\text{m}$	
3	TFT	Ø6		Cabeza truss	Acero al carbono estampado, recubrimiento cincado $\geq 5 \mu\text{m}$	
4	TFP	Ø5 - Ø8		Cabeza "pan"	Acero al carbono estampado, recubrimiento cincado $\geq 5 \mu\text{m}$	
5	TFN	Ø14		Cabeza hexagonal	Acero al carbono estampado, recubrimiento cincado $\geq 5 \mu\text{m}$	
6	TFF	Ø5 - Ø8		Cabeza con manguito	Acero al carbono estampado, recubrimiento cincado $\geq 5 \mu\text{m}$	
7	TFM	Ø6		Cabeza hexagonal con arandela estampada y eje proyectado	Acero al carbono estampado, recubrimiento cincado $\geq 5 \mu\text{m}$	
8	TFS	Ø6 - Ø10		Cabeza con eje proyectado arandela y tuerca	Acero al carbono estampado, recubrimiento cincado $\geq 5 \mu\text{m}$	

2. DATOS INSTALACIÓN

2.1. PLANO DE INSTALACIÓN

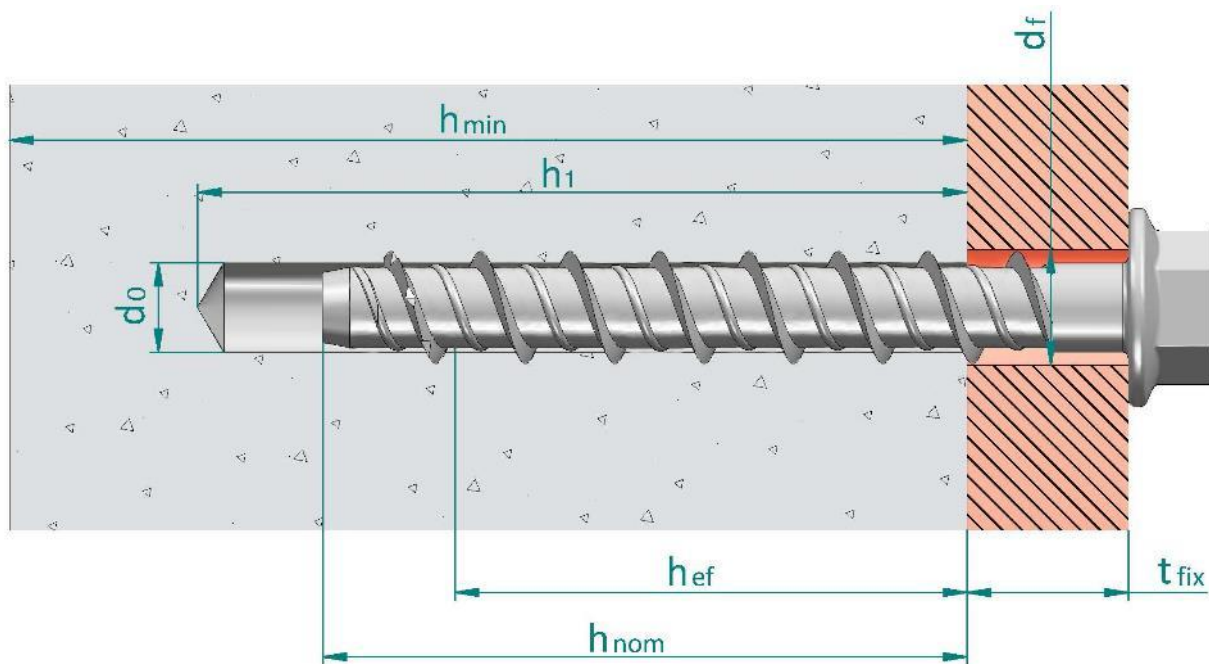

- d_0 : Diámetro nominal de broca
- d_b : Espesor del fondo de la losa
- d_f : Diámetro del taladro de paso en la placa de anclaje
- h_{ef} : Profundidad efectiva del anclaje
- h_1 : Profundidad del agujero
- h_{nom} : Profundidad de instalación en el hormigón
- h_{min} : Espesor mínimo del elemento de hormigón
- t_{fix} : Espesor de la placa de anclaje

Posición admisible del anclaje

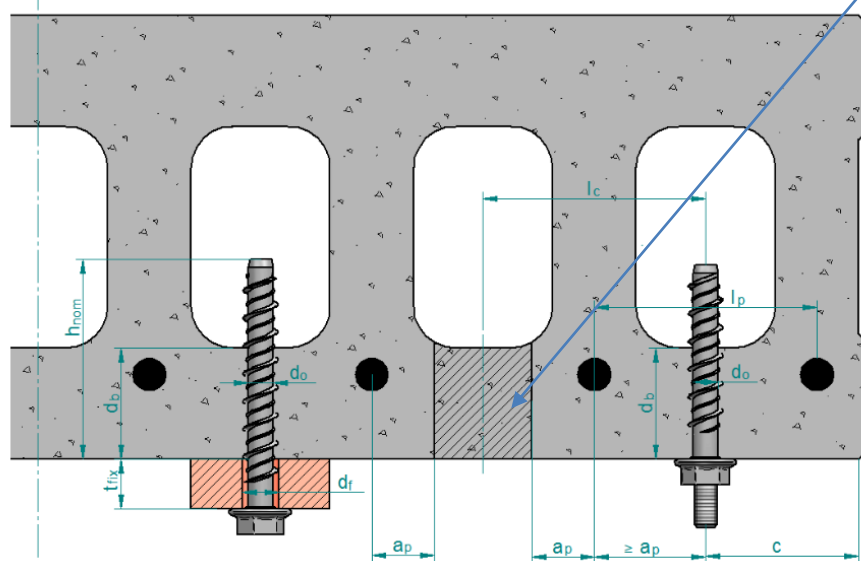

2.2. HOMOLOGACION PARA CARGAS SISMICAS

Familia	Código	Medida (Letra)	Homologado	C1	C2	Familia	Código	Medida (Letra)	Homologado	C1	C2
[--]	[--]	[--]	ETA	[--]	[--]	[--]	[--]	[--]	ETA	[--]	[--]
TFE	TFE05040	Ø5 x 40 (A)	✓*	--	--	TFA	TFA05040	Ø5 x 40 (A)	✓*	--	--
	TFE05050	Ø5 x 50 (A)	✓*	--	--		TFA05060	Ø5 x 60 (B)	✓*	--	--
	TFE05060	Ø5 x 60 (B)	✓*	--	--		TFA05080	Ø5 x 80 (D)	✓*	--	--
	TFE05080	Ø5 x 80 (D)	✓*	--	--		TFA05100	Ø5 x 100 (E)	✓*	--	--
	TFE05100	Ø5 x 100 (E)	✓*	--	--		TFA06045	Ø6 x 45	✓	--	--
	TFE06035	Ø6 x 35	✓	--	--		TFA06050	Ø6 x 50	✓	✓	--
	TFE06040	Ø6 x 40	✓	--	--		TFA06060	Ø6 x 60	✓	✓	--
	TFE06045	Ø6 x 45	✓	✓	--		TFA06080	Ø6 x 80	✓	✓	--
	TFE06050	Ø6 x 50	✓	✓	--		TFA06100	Ø6 x 120	✓	✓	--
	TFE06060	Ø6 x 60	✓	✓	--		TFA06120	Ø6 x 120	✓	✓	--
	TFE06070	Ø6 x 70	✓	✓	--		TFA06140	Ø6 x 140	✓	✓	--
	TFE06080	Ø6 x 80	✓	✓	--		TFA08060	Ø8 x 60	✓	✓	✓
	TFE06100	Ø6 x 100	✓	✓	--		TFA08080	Ø8 x 80	✓	✓	✓
	TFE06120	Ø6 x 120	✓	✓	--		TFA08100	Ø8 x 100	✓	✓	✓
	TFE08055	Ø8 x 55	✓	✓	✓		TFA08120	Ø8 x 120	✓	✓	✓
	TFE08060	Ø8 x 60	✓	✓	✓		TFA10100	Ø10 x 100	✓	✓	✓
	TFE08070	Ø8 x 70	✓	✓	✓		TFA10120	Ø10 x 120	✓	✓	✓
	TFE08075	Ø8 x 75	✓	✓	✓		TFT06040	Ø5 x 40 (A)	✓	--	--
	TFE08080	Ø8 x 80	✓	✓	✓		TFT06050	Ø5 x 60 (B)	✓	✓	--
	TFE08090	Ø8 x 90	✓	✓	✓		TFT06060	Ø5 x 80 (D)	✓	✓	--
	TFE08100	Ø8 x 100	✓	✓	✓	TFP05040	Ø5 x 40 (A)	✓*	--	--	
	TFE08110	Ø8 x 110	✓	✓	✓	TFP05060	Ø5 x 60 (B)	✓*	--	--	
	TFE08120	Ø8 x 120	✓	✓	✓	TFP06040	Ø6 x 40	✓	--	--	
	TFE08140	Ø8 x 140	✓	✓	✓	TFP06050	Ø6 x 50	✓	✓	--	
	TFE10060	Ø10 x 60	✓	--	--	TFP06060	Ø6 x 60	✓	✓	--	
	TFE10070	Ø10 x 70	✓	--	--	TFP06080	Ø6 x 80	✓	✓	--	
	TFE10080	Ø10 x 80	✓	--	--	TFP06100	Ø6 x 100	✓	✓	--	
	TFE10090	Ø10 x 90	✓	✓	✓	TFP08060	Ø8 x 60	✓	✓	✓	
	TFE10100	Ø10 x 100	✓	✓	✓	TFP08080	Ø8 x 80	✓	✓	✓	
	TFE10120	Ø10 x 120	✓	✓	✓	TFF05035S	Ø5 x 35 (M6)	✓*	--	--	
	TFE10140	Ø10 x 140	✓	✓	✓	TFF06035	Ø6 x 35 (M8-M10)	✓	--	--	
	TFE10160	Ø10 x 160	✓	✓	✓	TFF06040	Ø6 x 40 (M8-M10)	✓	--	--	
	TFE10180	Ø10 x 180	✓	✓	✓	TFF06055	Ø6 x 55 (M8-M10)	✓	--	--	
	TFE12080	Ø12 x 80	✓	--	--	TFF08050T	Ø8 x 50 (M10)	✓	--	--	
	TFE12090	Ø12 x 90	✓	--	--	TFF08050W	Ø8 x 50 (M12)	✓	--	--	
	TFE12100	Ø12 x 100	✓	✓	✓	TFM06035	Ø6 x 35 (M8)	✓	--	--	
	TFE12110	Ø12 x 110	✓	✓	✓	TFM06055	Ø6 x 55 (M10)	✓	--	--	
	TFE12130	Ø12 x 130	✓	✓	✓	TFN14080	Ø14 x 80	✓	--	--	
	TFE12150	Ø12 x 150	✓	✓	✓	TFS06100	Ø6 x 100 (M8)	✓	✓	--	
	TFE14080	Ø14 x 80	✓	--	--	TFS06120	Ø6 x 120 (M8)	✓	✓	--	
TFE14100	Ø14 x 100	✓	--	--	TFS08110	Ø8 x 110 (M10)	✓	✓	✓		
TFE14110	Ø14 x 110	✓	✓	✓	TFS08130	Ø8 x 130 (M10)	✓	✓	✓		
TFE14120	Ø14 x 120	✓	✓	✓	TFS10120	Ø10 x 120 (M12)	✓	--	--		
TFE14130	Ø14 x 130	✓	✓	✓	TFS10140	Ø10 x 140 (M12)	✓	--	--		
TFE14140	Ø14 x 140	✓	✓	✓							
TFE14160	Ø14 x 160	✓	✓	✓							
TFE16100	Ø16 x 100	✓	--	--							
TFE16150	Ø16 x 150	✓	--	--							
TFE18100	Ø18 x 100	✓	--	--							
TFE18130	Ø18 x 130	✓	--	--							
TFE18160	Ø18 x 160	✓	✓	✓							
TFE18180	Ø18 x 180	✓	✓	✓							
TFE18200	Ø18 x 200	✓	✓	✓							

3.PARAMETROS DE INSTALACIÓN (HORMIGON)

Parámetros de instalación generales											Profundidad de instalación estándar ($h_{ef, std}$)								Profundidad de instalación reducida ($h_{ef, red}$)									
Familia	Código	Medida (Letra)	Homologado	Diámetro de broca	Diámetro del agujero del espesor a fijar	Llave de instalación	Par de instalación máximo	Distancia mínima entre anclajes	Distancia mínima al borde	Esesor mínimo de hormigón	Profundidad del taladro	Profundidad instalación	Profundidad efectiva	Esesor a fijar	Distancia crítica entre ejes (cono)	Distancia crítica al borde (cono)	Distancia crítica entre ejes (fisuración)	Distancia crítica al borde (fisuración)	Esesor mínimo de hormigón	Profundidad del taladro	Profundidad instalación	Profundidad efectiva	Esesor a fijar	Distancia crítica entre ejes (cono)	Distancia crítica al borde (cono)	Distancia crítica entre ejes (fisuración)	Distancia crítica al borde (fisuración)	
[--]	[--]	[--]	ETA	d_0 [mm]	d_f [mm]	SW/Tx [--]	T_{inst} [Nm]	S_{min} [mm]	C_{min} [mm]	h_{min} [mm]	h_1 [mm]	h_{nom} [mm]	h_{ef} [mm]	t_{fix} [mm]	$S_{cr,N}$ [mm]	$C_{cr,N}$ [mm]	$S_{cr,sp}$ [mm]	$C_{cr,sp}$ [mm]	h_{min} [mm]	h_1 [mm]	h_{nom} [mm]	h_{ef} [mm]	t_{fix} [mm]	$S_{cr,N}$ [mm]	$C_{cr,N}$ [mm]	$S_{cr,sp}$ [mm]	$C_{cr,sp}$ [mm]	
TFE	TFE05040	Ø5 x 40(A)	✓*	5	6,5 - 8	SW 8	8	35	35	--	--	--	--	--	--	--	--	--	80	45	35	26,5	5	80	40	80	40	
	TFE05050	Ø5 x 50(A)	✓*			SW 8				5																		
	TFE05060	Ø5 x 60(B)	✓*			SW 8				15																		
	TFE05080	Ø5 x 80(D)	✓*			SW 8				35																		
	TFE05100	Ø5 x 100(E)	✓*			SW 8				55																		
	TFE06035	Ø6 x 35	✓	6	7,5 - 9	SW 10	10	35	35	--	--	--	--	--	--	--	--	--	--	100	45	35	26,0	--	78	39	90	45
	TFE06040	Ø6 x 40	✓			SW 10				5																		
	TFE06045	Ø6 x 45	✓			SW 10				10																		
	TFE06050	Ø6 x 50	✓			SW 10				15																		
	TFE06060	Ø6 x 60	✓			SW 10				25																		
	TFE06070	Ø6 x 70	✓			SW 10				35																		
	TFE06080	Ø6 x 80	✓			SW 10				45																		
	TFE06100	Ø6 x 100	✓			SW 10				65																		
	TFE06120	Ø6 x 120	✓			SW 10				85																		
	TFE08055	Ø8 x 55	✓			8				10,5 - 12	SW 13	20	35	35	--	--	--	--	--					--				
	TFE08060	Ø8 x 60	✓	SW 13	10																							
	TFE08070	Ø8 x 70	✓	SW 13	20																							
	TFE08075	Ø8 x 75	✓	SW 13	25																							
	TFE08080	Ø8 x 80	✓	SW 13	30																							
	TFE08090	Ø8 x 90	✓	SW 13	40																							
	TFE08100	Ø8 x 100	✓	SW 13	50																							
	TFE08110	Ø8 x 110	✓	SW 13	60																							
	TFE08120	Ø8 x 120	✓	SW 13	70																							
	TFE08140	Ø8 x 140	✓	SW 13	90																							

*Ø5 Homologado solamente para uso en hormigón y en losas alveolares prefabricadas para sistemas no-estructurales redundantes

Parámetros de instalación generales										Profundidad de instalación estándar ($h_{ef, std}$)								Profundidad de instalación reducida ($h_{ef, red}$)										
Familia	Código	Medida (Letra)	Homologado	Diámetro de broca	Diámetro del agujero del espesor a fijar	Llave de instalación	Par de instalación máximo	Distancia mínima entre anclajes	Distancia mínima al borde	Esesor mínimo de hormigón	Profundidad del taladro	Profundidad instalación	Profundidad efectiva	Esesor a fijar	Distancia crítica entre ejes (cono)	Distancia crítica al borde (cono)	Distancia crítica entre ejes (fisuración)	Distancia crítica al borde (fisuración)	Esesor mínimo de hormigón	Profundidad del taladro	Profundidad instalación	Profundidad efectiva	Esesor a fijar	Distancia crítica entre ejes (cono)	Distancia crítica al borde (cono)	Distancia crítica entre ejes (fisuración)	Distancia crítica al borde (fisuración)	
[--]	[--]	[--]	ETA	d_0	d_f	SW/Tx	T_{inst}	S_{min}	C_{min}	h_{min}	h_1	h_{nom}	h_{ef}	t_{fix}	$S_{cr,N}$	$C_{cr,N}$	$S_{cr,sp}$	$C_{cr,sp}$	h_{min}	h_1	h_{nom}	h_{ef}	t_{fix}	$S_{cr,N}$	$C_{cr,N}$	$S_{cr,sp}$	$C_{cr,sp}$	
				[mm]	[mm]	[--]	[Nm]	[mm]	[mm]	[mm]	[mm]	[mm]	[mm]	[mm]	[mm]	[mm]	[mm]	[mm]	[mm]	[mm]	[mm]	[mm]	[mm]	[mm]	[mm]	[mm]	[mm]	[mm]
TFE	TFE10060	Ø10 x 60	✓	10	12,5 - 14	SW 15	30	50	40	--	--	--	--	--	--	--	--	--	100	65	55	41,5	5	125	63	140	70	
	TFE10070	Ø10 x 70	✓			15																						
	TFE10080	Ø10 x 80	✓			25																						
	TFE10090	Ø10 x 90	✓			35																						
	TFE10100	Ø10 x 100	✓			5																						
	TFE10120	Ø10 x 120	✓			15																						
	TFE10140	Ø10 x 140	✓			35																						
	TFE10160	Ø10 x 160	✓			55																						
	TFE10180	Ø10 x 180	✓			75																						
	TFE12080	Ø12 x 80	✓	12	14,8 - 16	SW 18	50	75	45	--	--	--	--	--	--	--	--	--	120	90	75	58,0	5	174	87	190	95	
	TFE12090	Ø12 x 90	✓			15																						
	TFE12100	Ø12 x 100	✓			25																						
	TFE12110	Ø12 x 110	✓			35																						
	TFE12130	Ø12 x 130	✓			5																						
	TFE12150	Ø12 x 150	✓	170																								
	TFE14080	Ø14 x 80	✓	14	16,9 - 18	SW 21	70	80	50	--	--	--	--	--	--	--	--	--	120	90	75	58,0	5	174	87	190	95	
	TFE14100	Ø14 x 100	✓			15																						
	TFE14110	Ø14 x 110	✓			25																						
	TFE14120	Ø14 x 120	✓			35																						
	TFE14130	Ø14 x 130	✓			5																						
TFE14140	Ø14 x 140	✓	185																									
TFE14160	Ø14 x 160	✓	25																									
TFE16100	Ø16 x 100	✓	16	18,9 - 20	SW24	80	80	50	--	--	--	--	--	--	--	--	--	115	100	80	58	20	174	87	180	90		
TFE16150	Ø16 x 150	✓			70																							
TFE18100	Ø18 x 100	✓			10																							
TFE18130	Ø18 x 130	✓	18	20,9 - 22	SW 24	90	90	55	--	--	--	--	--	--	--	--	--	140	110	90	69,5	40	209	105	230	115		
TFE18160	Ø18 x 160	✓			70																							
TFE18180	Ø18 x 180	✓			90																							
TFE18200	Ø18 x 200	✓			225																							
					160																							

Parámetros de instalación generales										Profundidad de instalación estándar (h _{ef, std})								Profundidad de instalación reducida (h _{ef, red})										
Familia	Código	Medida (Letra)	Homologado	Diámetro de broca	Diámetro del agujero del espesor a fijar	Llave de instalación	Par de instalación máximo	Distancia mínima entre anclajes	Distancia mínima al borde	Esesor mínimo de hormigón	Profundidad del taladro	Profundidad instalación	Profundidad efectiva	Esesor a fijar	Distancia crítica entre ejes (cono)	Distancia crítica al borde (cono)	Distancia crítica entre ejes (fisuración)	Distancia crítica al borde (fisuración)	Esesor mínimo de hormigón	Profundidad del taladro	Profundidad instalación	Profundidad efectiva	Esesor a fijar	Distancia crítica entre ejes (cono)	Distancia crítica al borde (cono)	Distancia crítica entre ejes (fisuración)	Distancia crítica al borde (fisuración)	
[--]	[--]	[--]	ETA	d ₀	d _f	SW/Tx	T _{inst}	S _{min}	C _{min}	h _{min}	h ₁	h _{nom}	h _{ef}	t _{fix}	S _{cr,N}	C _{cr,N}	S _{cr,sp}	C _{cr,sp}	h _{min}	h ₁	h _{nom}	h _{ef}	t _{fix}	S _{cr,N}	C _{cr,N}	S _{cr,sp}	C _{cr,sp}	
				[mm]	[mm]	[--]	[Nm]	[mm]	[mm]	[mm]	[mm]	[mm]	[mm]	[mm]	[mm]	[mm]	[mm]	[mm]	[mm]	[mm]	[mm]	[mm]	[mm]	[mm]	[mm]	[mm]	[mm]	[mm]
TFA	TFA05040	Ø5 x 40(A)	✓*	5	6,5 - 8	TX25	8	35	35	80	55	45	35,0	15	105	53	105	53	80	45	35	26,5	5	80	40	80	40	
	TFA05060	Ø5 x 60(B)	✓*			25																						
	TFA05080	Ø5 x 80(D)	✓*			45																						
	TFA05100	Ø5 x 100(E)	✓*			65																						
	TFA06045	Ø6 x 45	✓	6	7,5 - 9	TX30	10	35	35	100	65	55	43,0	5	129	65	170	85	100	45	35	26,0	10	78	39	90	45	
	TFA06050	Ø6 x 50	✓			15																						
	TFA06060	Ø6 x 60	✓			25																						
	TFA06080	Ø6 x 80	✓			45																						
	TFA06100	Ø6 x 100	✓			65																						
	TFA06120	Ø6 x 120	✓			85																						
	TFA06140	Ø6 x 140	✓	105																								
	TFA08060	Ø8 x 60	✓	8	10,5 - 12	TX45	20	35	35	100	75	65	50,5	15	152	76	200	100	100	60	50	37,5	10	113	57	130	65	
	TFA08080	Ø8 x 80	✓			30																						
	TFA08100	Ø8 x 100	✓			50																						
TFA08120	Ø8 x 120	✓	70																									
TFA10100	Ø10 x 100	✓	10	12,5 - 14	TX50	30	50	40	135	95	85	67,0	15	201	101	210	105	100	65	55	41,5	45	125	63	140	70		
TFA10120	Ø10 x 120	✓			65																							
TFT	TFT06040	Ø6 x 40	✓	6	7,5 - 9	TX30	10	35	35	100	65	55	43,0	5	129	65	170	85	100	45	35	26,0	5	78	39	90	45	
	TFT06050	Ø6 x 50	✓			15																						
	TFT06060	Ø6 x 60	✓			25																						
TFP	TFP05040	Ø5 x 40(A)	✓*	5	6,5 - 8	TX30	8	35	35	80	55	45	35,0	15	105	53	105	53	80	45	35	26,5	5	80	40	80	40	
	TFP05060	Ø5 x 60(B)	✓*			25																						
	TFP06040	Ø6 x 40	✓	6	7,5 - 9	TX40	10	35	35	100	65	55	43,0	5	129	65	170	85	100	45	35	26,0	15	78	39	90	45	
	TFP06050	Ø6 x 50	✓			25																						
	TFP06060	Ø6 x 60	✓			45																						
	TFP06080	Ø6 x 80	✓			65																						
	TFP06100	Ø6 x 100	✓			85																						
TFP08060	Ø8 x 60	✓	8	10,5 - 12	TX45	20	35	35	100	75	65	50,5	15	152	76	200	100	100	60	50	37,5	10	113	57	130	65		
TFP08080	Ø8 x 80	✓			30																							
TFN	TFN14080	Ø14 x 80	✓	14	16,9 - 18	SW 24	70	80	50	--	--	--	--	--	--	--	--	--	120	90	75	58,0	5	174	87	190	95	

*Ø5 Homologado solamente para uso en hormigón y en losas alveolares prefabricadas para sistemas no-estructurales redundantes

Parámetros de instalación generales										Profundidad de instalación estándar ($h_{ef, std}$)								Profundidad de instalación reducida ($h_{ef, red}$)													
Familia	Código	Medida (Letra)	Homologado	Diámetro de broca	Diámetro del agujero del espesor a fijar	Llave de instalación	Par de instalación máximo	Distancia mínima entre anclajes	Distancia mínima al borde	Esesor mínimo de hormigón	Profundidad del taladro	Profundidad instalación	Profundidad efectiva	Esesor a fijar	Distancia crítica entre ejes (cono)	Distancia crítica al borde (cono)	Distancia crítica entre ejes (fisuración)	Distancia crítica al borde (fisuración)	Esesor mínimo de hormigón	Profundidad del taladro	Profundidad instalación	Profundidad efectiva	Esesor a fijar	Distancia crítica entre ejes (cono)	Distancia crítica al borde (cono)	Distancia crítica entre ejes (fisuración)	Distancia crítica al borde (fisuración)				
[--]	[--]	[--]	ETA	d_0 [mm]	d_f [mm]	SW/Tx [--]	T_{inst} [Nm]	S_{min} [mm]	C_{min} [mm]	h_{min} [mm]	h_1 [mm]	h_{nom} [mm]	h_{ef} [mm]	t_{fix} [mm]	$S_{cr,N}$ [mm]	$C_{cr,N}$ [mm]	$S_{cr,sp}$ [mm]	$C_{cr,sp}$ [mm]	h_{min} [mm]	h_1 [mm]	h_{nom} [mm]	h_{ef} [mm]	t_{fix} [mm]	$S_{cr,N}$ [mm]	$C_{cr,N}$ [mm]	$S_{cr,sp}$ [mm]	$C_{cr,sp}$ [mm]				
TFF	TFF05035S	Ø5 x 35 (M6)	✓*	5	--	SW10	8	35	35	--	--	--	--	--	--	--	--	--	80	45	35	26,5	--	80	40	80	40				
	TFF06035	Ø6 x 35 (M8-M10)	✓	6	--	SW 13	10	35	35	--	--	--	--	--	--	--	--	--	100	45	35	26,0	--	78	39	90	45				
	TFF06040	Ø6 x 40 (M8-M10)	✓			SW 13				--	--	--	--	--	--	--	--	--	--	--	--	--	100	45	35	26,0	--	78	39	90	45
	TFF06055	Ø6 x 55 (M8-M10)	✓			SW 13				100	65	55	43,0	--	129	65	170	85	--	--	--	--	--	--	--	--	--	--	--	--	--
	TFF08050T	Ø8 x 50 (M10)	✓	8	--	SW 13	20	35	35	--	--	--	--	--	--	--	--	--	100	60	50	37,5	--	113	57	130	65				
	TFF08050W	Ø8 x 50 (M12)	✓			SW 17				--	--	--	--	--	--	--	--	--	--	--	--	--	100	60	50	37,5	--	113	57	130	65
TFM	TFM06035	Ø6 x 35 (M8)	✓	6	--	SW 13	10	35	35	--	--	--	--	--	--	--	--	--	100	65	55	26,0	--	78	39	90	45				
	TFM06055	Ø6 x 55 (M10)	✓			SW 13				100	65	55	43,0	--	129	65	170	85	--	--	--	--	--	--	--	--	--	--	--	--	
TFS	TFS06100	Ø6 x 100 (M8)	✓	6	7,5 - 9	SW 5	10	35	35	100	65	55	43,0	35	129	65	170	85	100	45	35	26,0	55	78	39	90	45				
	TFS06120	Ø6 x 120 (M8)	✓			SW 5								55									75								
	TFS08110	Ø8 x 110 (M10)	✓	8	10,5 - 12	SW 7	20	35	35	100	75	65	50,5	29	152	76	200	100	100	60	50	37,5	47	113	57	130	65				
	TFS08130	Ø8 x 130 (M10)	✓			SW 7								49									75								
	TFS10120	Ø10 x 120 (M12)	✓	10	12,5 - 14	SW 8	30	50	40	120	85	75	58,5	27	176	88	190	95	100	65	55	41,5	52	125	63	140	70				
	TFS10140	Ø10 x 140 (M12)	✓			SW 8								47									75								

*Ø5 Homologado solamente para uso en hormigón y en losas alveolares prefabricadas para sistemas no-estructurales redundantes

4.PARAMETROS DE INSTALACIÓN (LOSAS ALVEOLARES) [Profundidad de instalación reducida/intermedia/estándar]

Parámetros de instalación generales											Profundidad de instalación (h_{ef1} / h_{ef2} / h_{ef3})																				
Familia	Código	Medida (Letra)	Homologado	Diámetro de broca	Diámetro del agujero del espesor a fijar	Llave de instalación	Par de instalación máximo	Distancia mínima entre anclajes	Distancia mínima al borde	Espesor del fondo de la losa	Profundidad del taladro	Profundidad instalación	Profundidad efectiva	Espesor a fijar	Distancia crítica entre ejes (cono)	Distancia crítica al borde(cono)	Distancia crítica entre ejes (fisuración)	Distancia crítica al borde(fisuración)													
[--]	[--]	[--]	ETA	d_o [mm]	d_f [mm]	SW/Tx [--]	T_{inst} [Nm]	S_{min} [mm]	C_{min} [mm]	d_b [mm]	h_1 [mm]	h_{nom} [mm]	h_{ef} [mm]	t_{fix} [mm]	$S_{cr,N}$ [mm]	$C_{cr,N}$ [mm]	$S_{cr,sp}$ [mm]	$C_{cr,sp}$ [mm]													
TFE	TFE05040	Ø5 x 40(A)	✓*	5	6,5 - 8	SW 8	8	35	35	25/30/40	30/40/45	30/40/45	20/22/26,5	10/--/--	60/66/80	30/33/40	80	80													
	TFE05050	Ø5 x 50(A)	✓*			20/10/5																									
	TFE05060	Ø5 x 60(B)	✓*			30/20/15																									
	TFE05080	Ø5 x 80(D)	✓*			50/40/35																									
	TFE05100	Ø5 x 100(E)	✓*			70/60/55																									
	TFE06035	Ø6 x 35	✓	6	7,5 - 9	SW 10	10	35	35	25/30/40	30/40/45	30/40/45	20/22/26	5/--/--	60/66/78	30/33/39	90	45													
	TFE06040	Ø6 x 40	✓			SW 10																									
	TFE06045	Ø6 x 45	✓			SW 10																									
	TFE06050	Ø6 x 50	✓			SW 10																									
	TFE06060	Ø6 x 60	✓			SW 10																									
	TFE06070	Ø6 x 70	✓			SW 10																									
	TFE06080	Ø6 x 80	✓			SW 10																									
	TFE06100	Ø6 x 100	✓			SW 10																									
TFE06120	Ø6 x 120	✓	SW 10																												
TFA	TFA05040	Ø5 x 40(A)	✓*	5	6,5 - 8	TX25	8	35	35	25/30/40	30/40/45	30/40/45	20/22/26,5	10/--/--	60/66/80	30/33/40	80	80													
	TFA05060	Ø5 x 60(B)	✓*			TX25																									
	TFA05080	Ø5 x 80(D)	✓*			TX25																									
	TFA05100	Ø5 x 100(E)	✓*			TX25																									
	TFA06045	Ø6 x 45	✓	6	7,5 - 9	TX30	10	35	35	25/30/40	30/40/45	30/40/45	20/22/26	15/5/--	60/66/78	30/33/39	90	45													
	TFA06050	Ø6 x 50	✓			TX30																									
	TFA06060	Ø6 x 60	✓			TX30																									
	TFA06080	Ø6 x 80	✓			TX30																									
	TFA06100	Ø6 x 100	✓			TX30																									
	TFA06120	Ø6 x 120	✓			TX30																									
	TFA06140	Ø6 x 140	✓			TX30																									
																											110/100/95				

*Ø5 Homologado solamente para uso en hormigón y en losas alveolares prefabricadas para sistemas no-estructurales redundantes

Parámetros de instalación generales										Profundidad de instalación ($h_{ef1}/ h_{ef2}/ h_{ef3}$)								
Familia	Código	Medida (Letra)	Homologado	Diámetro de broca	Diámetro del agujero del espesor a fijar	Llave de instalación	Par de instalación máximo	Distancia mínima entre anclajes	Distancia mínima al borde	Esesor del fondo de la losa	Profundidad del taladro	Profundidad instalación	Profundidad efectiva	Esesor a fijar	Distancia crítica entre ejes (cono)	Distancia crítica al borde (cono)	Distancia crítica entre ejes (fisuración)	Distancia crítica al borde (fisuración)
[--]	[--]	[--]	ETA	d_0	d_f	SW/Tx	T_{inst}	S_{min}	C_{min}	d_b	h_1	h_{nom}	h_{ef}	t_{fix}	$S_{cr,N}$	$C_{cr,N}$	$S_{cr,sp}$	$C_{cr,sp}$
				[mm]	[mm]	[--]	[Nm]	[mm]	[mm]	[mm]	[mm]	[mm]	[mm]	[mm]	[mm]	[mm]	[mm]	[mm]
TFT	TFT06040	Ø6 x 40	✓	6	7,5 - 9	TX30	10	35	35	25/30/40	30/40/45	30/40/45	20/22/26	10/--/--	60/66/78	30/33/39	90	45
	TFT06050	Ø6 x 50	✓			TX30								20/10/5				
	TFT06060	Ø6 x 60	✓			TX30								30/20/15				
TFP	TFP05040	Ø5 x 40(A)	✓*	5	6,5 - 8	TX30	8	35	35	25/30/40	30/40/45	30/40/45	20/22/26,5	10/--/--	60/66/80	30/33/40	80	80
	TFP05060	Ø5 x 60(B)	✓*			TX30								30/20/15				
	TFP06040	Ø6 x 40	✓	6	7,5 - 9	TX40	10	35	35	25/30/40	30/40/45	30/40/45	20/22/26	10/--/--	60/66/78	30/33/39	90	45
	TFP06050	Ø6 x 50	✓			TX40								20/10/5				
	TFP06060	Ø6 x 60	✓			TX40								30/20/15				
	TFP06080	Ø6 x 80	✓			TX40								50/40/35				
	TFP06100	Ø6 x 100	✓			TX40								70/60/55				
TFF	TFF05035S	Ø5 x 35 (M6)	✓*	5	6,5 - 8	SW10	8	35	35	25/30/40	30/40/45	30/40/45	20/22/26	--/--/--	60/66/80	30/33/40	80	80
	TFF06035	Ø6 x 35 (M8-M10)	✓	6	7,5 - 9	SW 13	10	35	35	25/30/40	30/40/45	30/40/45	20/22/26	--/--/--	60/66/78	30/33/39	90	45
	TFF06040	Ø6 x 40 (M8-M10)	✓															
	TFF06055	Ø6 x 55 (M8-M10)	✓															
TFM	TFM06035	Ø6 x 35 (M8)	✓	6	7,5 - 9	SW 13	10	35	35	25/30/40	30/40/45	30/40/45	20/22/26	--/--/--	60/66/78	30/33/39	90	45
	TFM06055	Ø6 x 55 (M10)	✓															
TFS	TFS06100	Ø6 x 100 (M8)	✓	6	7,5 - 9	SW 5	10	35	35	25/30/40	30/40/45	30/40/45	20/22/26	56/46/41	60/66/78	30/33/39	90	45
	TFS06120	Ø6 x 120 (M8)	✓											76/66/61				

*Ø5 Homologado solamente para uso en hormigón y en losas alveolares prefabricadas para sistemas no-estructurales redundantes

5. PROCESO DE INSTALACIÓN

5.1 INSTALACIÓN EN HORMIGÓN Y LOSAS ALVEOLARES

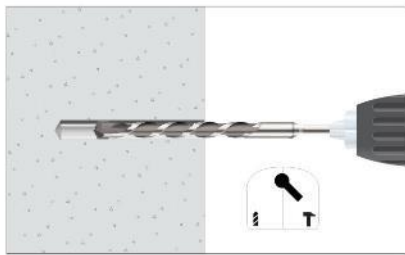

1. TALADRAR

Comprobar que el hormigón esté bien compactado y sin poros significativos.

Admisible en taladros secos, húmedos o inundados.

Taladro en posición percusión o martillo.

Taladrar a diámetro y profundidad especificados.



2. SOPLAR Y LIMPIAR

Limpiar el agujero de restos de polvo y fragmentos del taladrado según indicaciones del gráfico.

Utilizar bomba de aire y cepillo.

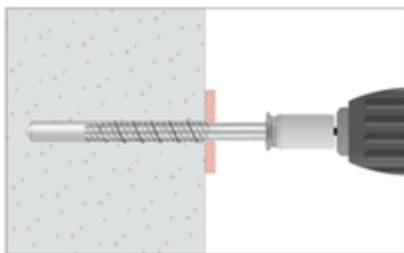

3. INSTALAR

Utilizar una llave de impacto que no exceda el torque máximo especificado en las tablas anteriores.

Utilizar el vaso o punta adecuado para cada medida.

La instalación debe hacerse a través del material a fijar.

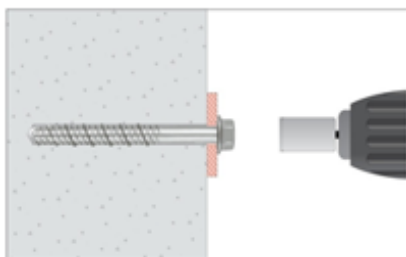

4. APLICAR EL PAR DE APRIETE

Insertar el anclaje en el agujero hasta que la cabeza quede enrasada con la superficie del material a fijar.

El anclaje tiene que ser ajustado después de la instalación.

6. RESISTENCIAS (HORMIGÓN)

Resistencias en hormigón C20/25 para un anclaje aislado sin efectos de distancia al borde ni de distancias entre anclajes es la indicada en la siguiente tabla:

Los valores subrayados y en cursiva indican fallo del acero, los valores en **negrita** indican fallo por hormigón y el resto indica fallo por extracción.
1 KN ≈ 100 kg

6.1 RESISTENCIAS CARACTERÍSTICAS (APLICACIONES ESTRUCTURALES) [kN]

Parámetros generales				Hormigón no fisurado				Hormigón fisurado											
Familia	Código	Medida	Homologado ETA	Tracción $N_{Rk, ucr}$		Cortadura $V_{Rk, ucr}$		Tracción $N_{Rk, cr}$		Cortadura $V_{Rk, cr}$									
				($h_{ef, std}$)	($h_{ef, red}$)	($h_{ef, std}$)	($h_{ef, red}$)	($h_{ef, std}$)	($h_{ef, red}$)	($h_{ef, std}$)	($h_{ef, red}$)								
TFE	TFE05040	Ø5 x 40	✓*	--	6,71	--	6,71	--	4,70	--	4,70								
	TFE05050	Ø5 x 50	✓*	10,19	6,71	<u>8,19</u>	6,71	7,13	4,70	7,13	4,70								
	TFE05060	Ø5 x 60	✓*																
	TFE05080	Ø5 x 80	✓*																
	TFE05100	Ø5 x 100	✓*																
	TFE06035	Ø6 x 35	✓	--	5,00	--	<u>12,53</u>	--	4,57	--	9,36								
	TFE06040	Ø6 x 40	✓																
	TFE06045	Ø6 x 45	✓																
	TFE06050	Ø6 x 50	✓																
	TFE06060	Ø6 x 60	✓	13,87	5,00	<u>12,53</u>	<u>12,53</u>	9,71	4,57	11,17	9,36								
	TFE06070	Ø6 x 70	✓																
	TFE06080	Ø6 x 80	✓																
	TFE06100	Ø6 x 100	✓																
	TFE06120	Ø6 x 120	✓																
	TFE08055	Ø8 x 55	✓									--	11,30	--	<u>19,57</u>	--	7,91	--	14,23
	TFE08060	Ø8 x 60	✓																
	TFE08070	Ø8 x 70	✓																
	TFE08075	Ø8 x 75	✓																
	TFE08080	Ø8 x 80	✓	17,65	11,30	<u>19,57</u>	<u>19,57</u>	12,36	7,91	15,69	14,23								
	TFE08090	Ø8 x 90	✓																
	TFE08100	Ø8 x 100	✓																
	TFE08110	Ø8 x 110	✓																
	TFE08120	Ø8 x 120	✓																
	TFE08140	Ø8 x 140	✓																
	TFE10060	Ø10 x 60	✓									--	13,15	--	25,65	--	9,21	--	17,95
	TFE10070	Ø10 x 70	✓																
	TFE10080	Ø10 x 80	✓																
	TFE10090	Ø10 x 90	✓																
	TFE10100	Ø10 x 100	✓	26,98	13,15	<u>27,40</u>	25,65	18,89	9,21	<u>27,40</u>	17,95								
	TFE10120	Ø10 x 120	✓																
	TFE10140	Ø10 x 140	✓																
	TFE10160	Ø10 x 160	✓																
	TFE10180	Ø10 x 180	✓																
	TFE12080	Ø12 x 80	✓	--	21,73	--	<u>37,24</u>	--	15,21	--	35,44								
	TFE12090	Ø12 x 90	✓																
	TFE12100	Ø12 x 100	✓																
	TFE12110	Ø12 x 110	✓																
	TFE12130	Ø12 x 130	✓	37,54	21,73	<u>37,24</u>	<u>37,24</u>	26,27	15,21	<u>37,24</u>	35,44								
	TFE12150	Ø12 x 150	✓																
	TFE14080	Ø14 x 80	✓									--	21,73	--	<u>52,72</u>	--	15,21	--	38,79
TFE14100	Ø14 x 100	✓																	
TFE14110	Ø14 x 110	✓																	
TFE14120	Ø14 x 120	✓																	
TFE14130	Ø14 x 130	✓	43,41	21,73	<u>52,72</u>	<u>52,72</u>	30,39	15,21	<u>52,72</u>	38,79									
TFE14140	Ø14 x 140	✓																	
TFE14160	Ø14 x 160	✓																	
TFE16100	Ø16 x 100	✓									--	43,41	--	<u>57,97</u>	46,50	30,39	15,21	<u>52,72</u>	32,55
TFE16150	Ø16 x 150	✓																	
TFE18100	Ø18 x 100	✓	--	28,50	--	75,82	--	19,95	--	53,07									
TFE18130	Ø18 x 130	✓																	
TFE18160	Ø18 x 160	✓																	
TFE18180	Ø18 x 180	✓	58,31								28,50	<u>80,78</u>	75,82	40,82	19,95	<u>80,78</u>	53,07		
TFE18200	Ø18 x 200	✓																	

Parámetros generales				Hormigón no fisurado				Hormigón fisurado			
Familia	Código	Medida	Homologado ETA	Tracción $N_{RK, ucr}$		Cortadura $V_{RK, ucr}$		Tracción $N_{RK, cr}$		Cortadura $V_{RK, cr}$	
				($h_{ef, std}$)	($h_{ef, red}$)	($h_{ef, std}$)	($h_{ef, red}$)	($h_{ef, std}$)	($h_{ef, red}$)	($h_{ef, std}$)	($h_{ef, red}$)
TFA	TFA05040	Ø5 x 40	✓*	--	6,71	--	6,71	--	4,70	--	4,70
	TFA05060	Ø5 x 60	✓*	10,19	6,71	8,19	6,71	7,13	4,70	7,13	4,70
	TFA05080	Ø5 x 80	✓*								
	TFA05100	Ø5 x 100	✓*								
	TFA06045	Ø6 x 45	✓	--	5,00	--	12,53	--	4,57	--	9,36
	TFA06050	Ø6 x 50	✓	--		--		--			
	TFA06060	Ø6 x 60	✓	13,87	5,00	12,53	12,53	9,71	4,57	11,17	9,36
	TFA06080	Ø6 x 80	✓								
	TFA06100	Ø6 x 100	✓								
	TFA06120	Ø6 x 120	✓								
	TFA06140	Ø6 x 140	✓								
	TFA08060	Ø8 x 60	✓	--	11,30	--	19,57	--	7,91	--	14,23
	TFA08080	Ø8 x 80	✓	17,65	11,30	19,57	19,57	12,36	7,91	15,69	14,23
TFA08100	Ø8 x 100	✓									
TFA08120	Ø8 x 120	✓									
TFA10100	Ø10 x 100	✓	26,98	13,15	27,40	25,65	18,89	9,21	27,40	17,95	
TFA10120	Ø10 x 120	✓									
TFT	TFT06040	Ø6 x 40	✓	--	5,00	--	12,53	--	4,57	--	9,36
	TFT06050	Ø6 x 50	✓	--		--		--			
	TFT06060	Ø6 x 60	✓	13,87	5,00	12,53	12,53	9,71	4,57	11,17	9,36
TFP	TFP05040	Ø5 x 40	✓*	--	6,71	--	6,71	--	4,70	--	4,70
	TFP05060	Ø5 x 60	✓*	10,19	6,71	8,19	6,71	7,13	4,70	7,13	4,70
	TFP06040	Ø6 x 40	✓	--	5,00	--	12,53	9,71	4,57	--	9,36
	TFP06050	Ø6 x 50	✓	--		--				--	
	TFP06060	Ø6 x 60	✓	13,87	5,00	12,53	12,53	9,71	4,57	11,17	9,36
	TFP06080	Ø6 x 80	✓								
	TFP06100	Ø6 x 100	✓								
	TFP08060	Ø8 x 60	✓	--	11,30	--	19,57	--	7,91	--	14,23
TFP08080	Ø8 x 80	✓	17,65	11,30	19,57	19,57	12,36	7,91	15,69	14,23	
TFN	TFN14080	Ø14 x 80	✓	--	21,73	--	52,72	--	15,21	--	38,79
TFF	TFF05035S	Ø5 x 35 (M6)	✓*	--	6,71	--	--	--	4,70	--	--
	TFF06035	Ø6 x 35 (M8-M10)	✓	--	5,00	--	--	--	4,57	--	--
	TFF06040	Ø6 x 40 (M8-M10)	✓	--		--	--	--			
	TFF06055	Ø6 x 55 (M8-M10)	✓	13,87	--	--	--	9,71	--	--	--
	TFF08050T	Ø8 x 50 (M10)	✓	--	11,30	--	--	--	7,91	--	--
	TFF08050W	Ø8 x 50 (M12)	✓	--		--	--	--			
TFM	TFM06035	Ø6 x 35 (M8)	✓	--	5,00	--	--	--	4,57	--	--
	TFM06055	Ø6 x 55 (M10)	✓	13,87	--	--	--	9,71	--	--	--
TFS	TFS06100	Ø6 x 100 (M8)	✓	13,87	5,00	12,53	12,53	9,71	4,57	11,17	9,36
	TFS06120	Ø6 x 120 (M8)	✓								
	TFS08110	Ø8 x 110 (M10)	✓								
	TFS08130	Ø8 x 130 (M10)	✓	17,65	11,30	19,57	19,57	12,36	7,91	15,69	14,23
	TFS10120	Ø10 x 120 (M12)	✓	22,01	13,15	27,40	25,65	15,41	9,21	20,34	17,95
	TFS10140	Ø10 x 140 (M12)	✓								

*Ø5 Homologado solamente para uso en hormigón y en losas alveolares prefabricadas para sistemas no-estructurales redundantes

6.2 RESISTENCIAS DE CALCULO (APLICACIONES ESTRUCTURALES) [kN]

Parámetros generales				Hormigón no fisurado				Hormigón fisurado							
Familia	Código	Medida	Homologado ETA	Tracción $N_{Rd,ucr}$		Cortadura $V_{Rd,ucr}$		Tracción $N_{Rd,cr}$		Cortadura $V_{Rd,cr}$					
				($h_{ef,sta}$)	($h_{ef,red}$)	($h_{ef,sta}$)	($h_{ef,red}$)	($h_{ef,sta}$)	($h_{ef,red}$)	($h_{ef,sta}$)	($h_{ef,red}$)				
TFE	TFE05040	Ø5 x 40	✓*	--	4,47	--	4,47	--	3,13	--	3,13				
	TFE05050	Ø5 x 50	✓*	6,79	4,47	<u>5,46</u>	4,47	4,75	3,13	4,75	3,13				
	TFE05060	Ø5 x 60	✓*												
	TFE05080	Ø5 x 80	✓*												
	TFE05100	Ø5 x 100	✓*												
	TFE06035	Ø6 x 35	✓	--	2,78	--	<u>8,35</u>	--	2,54	--	6,24				
	TFE06040	Ø6 x 40	✓	--		--		--							
	TFE06045	Ø6 x 45	✓	--		--		--							
	TFE06050	Ø6 x 50	✓	--		--		--							
	TFE06060	Ø6 x 60	✓	9,25	2,78	<u>8,35</u>	<u>8,35</u>	6,47	2,54	7,44	6,24				
	TFE06070	Ø6 x 70	✓												
	TFE06080	Ø6 x 80	✓												
	TFE06100	Ø6 x 100	✓												
	TFE06120	Ø6 x 120	✓	11,77	6,28	<u>13,05</u>	<u>13,05</u>	8,24	4,39	10,46	9,49				
	TFE08055	Ø8 x 55	✓												
	TFE08060	Ø8 x 60	✓												
	TFE08070	Ø8 x 70	✓												
	TFE08075	Ø8 x 75	✓	11,77	6,28	<u>13,05</u>	<u>13,05</u>	8,24	4,39	10,46	9,49				
	TFE08080	Ø8 x 80	✓												
	TFE08090	Ø8 x 90	✓												
	TFE08100	Ø8 x 100	✓												
	TFE08110	Ø8 x 110	✓	17,99	8,77	<u>18,27</u>	17,10	12,59	6,14	<u>18,27</u>	11,97				
	TFE08120	Ø8 x 120	✓												
	TFE08140	Ø8 x 140	✓												
	TFE10060	Ø10 x 60	✓												
	TFE10070	Ø10 x 70	✓	--	8,77	--	17,10	--	6,14	--	11,97				
	TFE10080	Ø10 x 80	✓	--		--		--							
	TFE10090	Ø10 x 90	✓	17,99		8,77		<u>18,27</u>		17,10		12,59	6,14	<u>18,27</u>	11,97
	TFE10100	Ø10 x 100	✓												
	TFE10120	Ø10 x 120	✓												
	TFE10140	Ø10 x 140	✓												
	TFE10160	Ø10 x 160	✓	25,02	14,49	<u>24,83</u>	<u>24,83</u>	17,52	10,14	<u>24,83</u>	23,63				
TFE10180	Ø10 x 180	✓													
TFE12080	Ø12 x 80	✓													
TFE12090	Ø12 x 90	✓													
TFE12100	Ø12 x 100	✓	--	14,49	--	<u>24,83</u>	--	10,14	--	23,63					
TFE12110	Ø12 x 110	✓	--		--		--								
TFE12130	Ø12 x 130	✓	25,02		14,49		<u>24,83</u>		<u>24,83</u>		17,52	10,14	<u>24,83</u>	23,63	
TFE12150	Ø12 x 150	✓													
TFE14080	Ø14 x 80	✓													
TFE14100	Ø14 x 100	✓													
TFE14110	Ø14 x 110	✓	--	21,73	--	<u>52,72</u>	--	15,21	--	38,79					
TFE14120	Ø14 x 120	✓	--		--		--								
TFE14130	Ø14 x 130	✓	43,41		21,73		<u>52,72</u>		<u>52,72</u>		30,39	15,21	<u>52,72</u>	38,79	
TFE14140	Ø14 x 140	✓													
TFE14160	Ø14 x 160	✓													
TFE16100	Ø16 x 100	✓													
TFE16150	Ø16 x 150	✓	--	14,49	--	<u>38,65</u>	--	10,14	--	21,70					
TFE18100	Ø18 x 100	✓	--		--		--								
TFE18130	Ø18 x 130	✓	19,00		19,00		<u>53,85</u>		50,54		13,30	13,30	35,38		
TFE18160	Ø18 x 160	✓													
TFE18180	Ø18 x 180	✓													
TFE18200	Ø18 x 200	✓													

Parámetros generales				Hormigón no fisurado				Hormigón fisurado			
Familia	Código	Medida	Homologado ETA	Tracción $N_{Rd,ucr}$		Cortadura $V_{Rd,ucr}$		Tracción $N_{Rd,cr}$		Cortadura $V_{Rd,cr}$	
				($h_{ef,sta}$)	($h_{ef,red}$)	($h_{ef,sta}$)	($h_{ef,red}$)	($h_{ef,sta}$)	($h_{ef,red}$)	($h_{ef,sta}$)	($h_{ef,red}$)
TFA	TFA05040	Ø5 x 40	✓*	--	4,47	--	4,47	--	3,13	--	3,13
	TFA05060	Ø5 x 60	✓*	6,79	4,47	5,46	4,47	4,75	3,13	4,75	3,13
	TFA05080	Ø5 x 80	✓*								
	TFA05100	Ø5 x 100	✓*								
	TFA06045	Ø6 x 45	✓	--	2,78	--	8,35	--	2,54	--	6,24
	TFA06050	Ø6 x 50	✓								
	TFA06060	Ø6 x 60	✓	9,25	2,78	8,35	8,35	6,47	2,54	7,44	6,24
	TFA06080	Ø6 x 80	✓								
	TFA06100	Ø6 x 100	✓								
	TFA06120	Ø6 x 120	✓								
	TFA06140	Ø6 x 140	✓								
	TFA08060	Ø8 x 60	✓	--	6,28	--	13,05	--	4,39	--	9,49
	TFA08080	Ø8 x 80	✓	11,77	6,28	13,05	13,05	8,24	4,39	10,46	9,49
TFA08100	Ø8 x 100	✓									
TFA08120	Ø8 x 120	✓									
TFA10100	Ø10 x 100	✓	17,99	8,77	18,27	17,10	12,59	6,14	18,27	11,97	
TFA10120	Ø10 x 120	✓									
TFT	TFT06040	Ø6 x 40	✓	--	2,78	--	8,35	--	2,54	--	6,24
	TFT06050	Ø6 x 50	✓								
	TFT06060	Ø6 x 60	✓	9,25	2,78	8,35	8,35	6,47	2,54	7,44	6,24
TFP	TFP05040	Ø5 x 40	✓*	--	4,47	--	4,47	--	3,13	--	3,13
	TFP05060	Ø5 x 60	✓*	6,79	4,47	5,46	4,47	4,75	3,13	4,75	3,13
	TFP06040	Ø6 x 40	✓	--	2,78	--	8,35	--	2,54	--	6,24
	TFP06050	Ø6 x 50	✓								
	TFP06060	Ø6 x 60	✓	9,25	2,78	8,35	8,35	6,47	2,54	7,44	6,24
	TFP06080	Ø6 x 80	✓								
	TFP06100	Ø6 x 100	✓								
	TFP08060	Ø8 x 60	✓	--	6,28	--	13,05	--	4,39	--	9,49
TFP08080	Ø8 x 80	✓	11,77	6,28	13,05	13,05	8,24	4,39	10,46	9,49	
TFN	TFN14080	Ø14 x 80	✓	--	14,49	--	35,15	--	10,14	--	25,86
TFF	TFF05035S	Ø5 x 35 (M6)	✓*	--	4,47	--	--	--	3,13	--	--
	TFF06035	Ø6 x 35 (M8-M10)	✓	--	2,78	--	--	--	2,54	--	--
	TFF06040	Ø6 x 40 (M8-M10)	✓								
	TFF06055	Ø6 x 55 (M8-M10)	✓	9,25	--	--	--	6,47	--	--	--
	TFF08050T	Ø8 x 50 (M10)	✓	--	6,28	--	--	--	4,39	--	--
	TFF08050W	Ø8 x 50 (M12)	✓								
TFM	TFM06035	Ø6 x 35 (M8)	✓	--	2,78	--	--	--	2,54	--	--
	TFM06055	Ø6 x 55 (M10)	✓	9,25	--	--	--	6,47	--	--	--
TFS	TFS06100	Ø6 x 100 (M8)	✓	9,25	2,78	8,35	8,35	6,47	2,54	7,44	6,24
	TFS06120	Ø6 x 120 (M8)	✓								
	TFS08110	Ø8 x 110 (M10)	✓	11,77	6,28	13,05	13,05	8,24	4,39	10,46	9,49
	TFS08130	Ø8 x 130 (M10)	✓								
	TFS10120	Ø10 x 120 (M12)	✓								
TFS10140	Ø10 x 140 (M12)	✓	14,67	8,77	18,27	17,10	10,27	6,14	13,56	11,97	

*Ø5 Homologado solamente para uso en hormigón y en losas alveolares prefabricadas para sistemas no-estructurales redundantes

6.3 CARGAS MAXIMAS RECOMENDADAS (APLICACIONES ESTRUCTURALES) [kN] (con $\gamma_F= 1.4$) [kN]

Parámetros generales				Hormigón no fisurado				Hormigón fisurado							
Familia	Código	Medida	Homologado ETA	Tracción $N_{rec, ucr}$		Cortadura $V_{rec, ucr}$		Tracción $N_{rec, cr}$		Cortadura $V_{rec, cr}$					
				($h_{ef, std}$)	($h_{ef, red}$)	($h_{ef, std}$)	($h_{ef, red}$)	($h_{ef, std}$)	($h_{ef, red}$)	($h_{ef, std}$)	($h_{ef, red}$)				
TFE	TFE05040	Ø5 x 40	✓*	--	3,20	--	3,20	--	2,24	--	2,24				
	TFE05050	Ø5 x 50	✓*	4,85	3,20	<u>3,90</u>	3,20	3,40	2,24	3,40	2,24				
	TFE05060	Ø5 x 60	✓*												
	TFE05080	Ø5 x 80	✓*												
	TFE05100	Ø5 x 100	✓*												
	TFE06035	Ø6 x 35	✓	--	1,98	--	<u>5,97</u>	--	1,81	--	4,46				
	TFE06040	Ø6 x 40	✓	--		--		--							
	TFE06045	Ø6 x 45	✓	--		--		--							
	TFE06050	Ø6 x 50	✓	--		--		--							
	TFE06060	Ø6 x 60	✓	6,61	1,98	<u>5,97</u>	<u>5,97</u>	4,62	1,81	5,32	4,46				
	TFE06070	Ø6 x 70	✓												
	TFE06080	Ø6 x 80	✓												
	TFE06100	Ø6 x 100	✓												
	TFE06120	Ø6 x 120	✓	8,41	4,48	<u>9,32</u>	<u>9,32</u>	5,88	3,14	7,47	6,78				
	TFE08055	Ø8 x 55	✓												
	TFE08060	Ø8 x 60	✓												
	TFE08070	Ø8 x 70	✓												
	TFE08075	Ø8 x 75	✓	8,41	4,48	<u>9,32</u>	<u>9,32</u>	5,88	3,14	7,47	6,78				
	TFE08080	Ø8 x 80	✓												
	TFE08090	Ø8 x 90	✓												
	TFE08100	Ø8 x 100	✓												
	TFE08110	Ø8 x 110	✓	12,85	6,26	<u>13,05</u>	12,21	8,99	4,38	<u>13,05</u>	8,55				
	TFE08120	Ø8 x 120	✓												
	TFE08140	Ø8 x 140	✓												
	TFE10060	Ø10 x 60	✓												
	TFE10070	Ø10 x 70	✓	--	6,26	--	12,21	--	4,38	--	8,55				
	TFE10080	Ø10 x 80	✓	--		--		--							
	TFE10090	Ø10 x 90	✓	12,85		6,26		<u>13,05</u>		12,21		8,99	4,38	<u>13,05</u>	8,55
	TFE10100	Ø10 x 100	✓												
	TFE10120	Ø10 x 120	✓												
	TFE10140	Ø10 x 140	✓												
	TFE10160	Ø10 x 160	✓	17,87	10,35	<u>17,73</u>	<u>17,73</u>	12,51	7,24	<u>17,73</u>	16,88				
TFE10180	Ø10 x 180	✓													
TFE12080	Ø12 x 80	✓													
TFE12090	Ø12 x 90	✓													
TFE12090	Ø12 x 90	✓	--	10,35	--	<u>17,73</u>	--	7,24	--	16,88					
TFE12100	Ø12 x 100	✓	--		--		--								
TFE12110	Ø12 x 110	✓	17,87		10,35		<u>17,73</u>		<u>17,73</u>		12,51	7,24	<u>17,73</u>	16,88	
TFE12130	Ø12 x 130	✓													
TFE12150	Ø12 x 150	✓													
TFE14080	Ø14 x 80	✓													
TFE14100	Ø14 x 100	✓	--	10,35	--	<u>25,10</u>	--	7,24	--	18,47					
TFE14110	Ø14 x 110	✓	--		--		--								
TFE14120	Ø14 x 120	✓	20,67		10,35		<u>25,10</u>		<u>25,10</u>		14,47	7,24	<u>25,10</u>	18,47	
TFE14130	Ø14 x 130	✓													
TFE14140	Ø14 x 140	✓													
TFE14160	Ø14 x 160	✓													
TFE16100	Ø16 x 100	✓	--	--	--	--	14,47	7,24	<u>27,60</u>	15,50					
TFE16150	Ø16 x 150	✓	20,67	10,35	<u>27,60</u>	22,14									
TFE18100	Ø18 x 100	✓	--	13,57	--	36,10	--	9,50	--	25,27					
TFE18130	Ø18 x 130	✓	--		--		--								
TFE18160	Ø18 x 160	✓	27,77		13,57		<u>38,47</u>		36,10		19,44	9,50	<u>38,47</u>	25,27	
TFE18180	Ø18 x 180	✓													
TFE18200	Ø18 x 200	✓	--	--	--	--	--	--	--	--					

Parámetros generales				Hormigón no fisurado				Hormigón fisurado			
Familia	Código	Medida	Homologado ETA	Tracción $N_{Rd,ucr}$		Cortadura $V_{Rd,ucr}$		Tracción $N_{Rd,cr}$		Cortadura $V_{Rd,cr}$	
				($h_{ef, std}$)	($h_{ef, red}$)	($h_{ef, std}$)	($h_{ef, red}$)	($h_{ef, std}$)	($h_{ef, red}$)	($h_{ef, std}$)	($h_{ef, red}$)
TFA	TFA05040	Ø5 x 40	✓*	--	3,20	--	3,20	--	2,24	--	2,24
	TFA05060	Ø5 x 60	✓*	4,85	3,20	3,90	3,20	3,40	2,24	3,40	2,24
	TFA05080	Ø5 x 80	✓*								
	TFA05100	Ø5 x 100	✓*								
	TFA06045	Ø6 x 45	✓	--	1,98	--	5,97	--	1,81	--	4,46
	TFA06050	Ø6 x 50	✓								
	TFA06060	Ø6 x 60	✓	6,61	1,98	5,97	5,97	4,62	1,81	5,32	4,46
	TFA06080	Ø6 x 80	✓								
	TFA06100	Ø6 x 100	✓								
	TFA06120	Ø6 x 120	✓								
	TFA06140	Ø6 x 140	✓								
	TFA08060	Ø8 x 60	✓	--	4,48	--	9,32	--	3,14	--	6,78
	TFA08080	Ø8 x 80	✓								
TFA08100	Ø8 x 100	✓	8,41	4,48	9,32	9,32	5,88	3,14	7,47	6,78	
TFA08120	Ø8 x 120	✓									
TFA10100	Ø10 x 100	✓									
TFA10120	Ø10 x 120	✓	12,85	6,26	13,05	12,21	8,99	4,38	13,05	8,55	
TFT	TFT06040	Ø6 x 40	✓	--	1,98	--	5,97	--	1,81	--	4,46
	TFT06050	Ø6 x 50	✓								
	TFT06060	Ø6 x 60	✓	6,61	1,98	5,97	5,97	4,62	1,81	5,32	4,46
TFP	TFP05040	Ø5 x 40	✓*	--	3,20	--	3,20	--	2,24	--	2,24
	TFP05060	Ø5 x 60	✓*	4,85		3,20		3,90		3,20	
	TFP06040	Ø6 x 40	✓								
	TFP06050	Ø6 x 50	✓								
	TFP06060	Ø6 x 60	✓	6,61	1,98	5,97	5,97	4,62	1,81	5,32	4,46
	TFP06080	Ø6 x 80	✓								
	TFP06100	Ø6 x 100	✓								
	TFP08060	Ø8 x 60	✓								
TFP08080	Ø8 x 80	✓	8,41	4,48	9,32	9,32	5,88	3,14	7,47	6,78	
TFN	TFN14080	Ø14 x 80	✓	--	10,35	--	25,10	--	7,24	--	18,47
TFF	TFF05035S	Ø5 x 35 (M6)	✓*	--	3,20	--	--	--	2,24	--	--
	TFF06035	Ø6 x 35 (M8-M10)	✓	--		1,98	--	--		--	1,81
	TFF06040	Ø6 x 40 (M8-M10)	✓								
	TFF06055	Ø6 x 55 (M8-M10)	✓	6,61	--		--	--	4,62	--	
	TFF08050T	Ø8 x 50 (M10)	✓	--	4,48	--	9,32	--	3,14	--	--
	TFF08050W	Ø8 x 50 (M12)	✓								
TFM	TFM06035	Ø6 x 35 (M8)	✓	--	1,98	--	--	--	1,81	--	--
	TFM06055	Ø6 x 55 (M10)	✓	6,61	--	--	--	4,62	--	--	--
TFS	TFS06100	Ø6 x 100 (M8)	✓	6,61	1,98	5,97	5,97	4,62	1,81	5,32	4,46
	TFS06120	Ø6 x 120 (M8)	✓								
	TFS08110	Ø8 x 110 (M10)	✓								
	TFS08130	Ø8 x 130 (M10)	✓	8,41	4,48	9,32	9,32	5,88	3,14	7,47	6,78
	TFS10120	Ø10 x 120 (M12)	✓								
	TFS10140	Ø10 x 140 (M12)	✓								

*Ø5 Homologado solamente para uso en hormigón y en losas alveolares prefabricadas para sistemas no-estructurales redundantes

COEFICIENTES DE MAYORACIÓN A EXTRACCIÓN PARA CARGA A TRACCIÓN EN HORMIGONES DE ALTA RESISTENCIA ω_c															
Diámetro	Ø5		Ø6		Ø8		Ø10			Ø12		Ø14		Ø18	
Profundidad de instalación	($h_{ef, red}$)	($h_{ef, std}$)	($h_{ef, red}$)	($h_{ef, std}$)	($h_{ef, red}$)	($h_{ef, std}$)	($h_{ef, 1}$)	($h_{ef, 2}$)	($h_{ef, 3}$)	($h_{ef, red}$)	($h_{ef, std}$)	($h_{ef, red}$)	($h_{ef, std}$)	($h_{ef, red}$)	($h_{ef, std}$)
C30/37	1,00	1,00	1,16	1,22	1,21	1,22	1,22	1,17	1,22	1,16	1,22	1,21	1,20	1,22	1,17
C40/50	1,00	1,00	1,28	1,41	1,39	1,41	1,41	1,30	1,41	1,29	1,41	1,39	1,37	1,40	1,32
C50/60	1,00	1,00	1,39	1,58	1,54	1,58	1,58	1,42	1,58	1,40	1,58	1,55	1,51	1,57	1,42

7. RESISTENCIAS (LOSAS ALVEOLARES)

Resistencias en losas alveolares C30/37 para un anclaje aislado sin efectos de distancia al borde ni de distancias entre anclajes es la indicada en la siguiente tabla:

Los valores subrayados y en cursiva indican fallo del acero, los valores en **negrita** indican fallo por hormigón y el resto indica fallo por extracción.

1 KN ≈ 100 kg

7.1 RESISTENCIAS CARACTERÍSTICAS (APLICACIONES NO ESTRUCTURALES) [kN]

Parámetros generales				Losas Alveolares					
Familia	Código	Medida	Homologado ETA	Tracción N _{Rk}			Cortadura V _{Rk}		
				(h _{ef1})	(h _{ef2})	(h _{ef3})	(h _{ef1})	(h _{ef2})	(h _{ef3})
TFE	TFE05040	Ø5 x 40	✓*	5,39	--	--	5,39	--	--
	TFE05050	Ø5 x 50	✓*		--	--		--	--
	TFE05060	Ø5 x 60	✓*		6,22	8,22		6,22	<u>8,19</u>
	TFE05080	Ø5 x 80	✓*						
	TFE05100	Ø5 x 100	✓*						
	TFE06035	Ø6 x 35	✓	5,39	--	--	5,39	--	--
	TFE06040	Ø6 x 40	✓		--	--		--	--
	TFE06045	Ø6 x 45	✓		--	--		--	--
	TFE06050	Ø6 x 50	✓		6,22	7,99		6,22	7,99
	TFE06060	Ø6 x 60	✓						
	TFE06070	Ø6 x 70	✓						
	TFE06080	Ø6 x 80	✓						
	TFE06100	Ø6 x 100	✓						
	TFE06120	Ø6 x 120	✓						
TFA05040	Ø5 x 40	✓*	5,39		--	--		5,39	--
TFA05060	Ø5 x 60	✓*		6,22	8,22	6,22	<u>8,19</u>		
TFA05080	Ø5 x 80	✓*							
TFA05100	Ø5 x 100	✓*							
TFA	TFA06045	Ø6 x 45	✓	5,39	--	--	5,39	--	--
	TFA06050	Ø6 x 50	✓		--	--		--	--
	TFA06060	Ø6 x 60	✓		6,22	7,99		6,22	7,99
	TFA06080	Ø6 x 80	✓						
	TFA06100	Ø6 x 100	✓						
	TFA06120	Ø6 x 120	✓						
	TFA06140	Ø6 x 140	✓						
	TFT06040	Ø6 x 40	✓		5,39	--		--	5,39
TFT06050	Ø6 x 50	✓	6,22	7,99		6,22	7,99		
TFT06060	Ø6 x 60	✓							
THP	TFP05040	Ø5 x 40	✓*	5,39	--	--	5,39	--	--
	TFP05060	Ø5 x 60	✓*		6,22	8,22		6,22	<u>8,19</u>
	TFP06040	Ø6 x 40	✓	5,39	--	--	5,39	--	--
	TFP06050	Ø6 x 50	✓		6,22	7,99		6,22	7,99
	TFP06060	Ø6 x 60	✓						
	TFP06080	Ø6 x 80	✓						
TFP06100	Ø6 x 100	✓							
TFF	TFF05035S	Ø5 x 35 (M6)	✓*	5,39	6,22	8,22	5,39	6,22	<u>8,19</u>
	TFF06035	Ø6 x 35 (M8-M10)	✓	5,39	6,22	7,99	5,39	6,22	7,99
	TFF06040	Ø6 x 40 (M8-M10)	✓						
	TFF06055	Ø6 x 55 (M8-M10)	✓						
TFM	TFM06035	Ø6 x 35 (M8)	✓	5,39	6,22	7,99	5,39	6,22	7,99
	TFM06055	Ø6 x 55 (M10)	✓						
TFS	TFS06100	Ø6 x 100 (M8)	✓	5,39	6,22	7,99	5,39	6,22	7,99
	TFS06120	Ø6 x 120 (M8)	✓						

*Ø5 Homologado solamente para uso en hormigón y en losas alveolares prefabricadas para sistemas no-estructurales redundantes

7.2 RESISTENCIAS DE CALCULO (APLICACIONES NO ESTRUCTURALES) [kN]									
Parámetros generales				Losas Alveolares					
Familia	Código	Medida	Homologado ETA	Tracción N_{Rd}			Cortadura V_{Rd}		
				(h_{ef1})	(h_{ef2})	(h_{ef3})	(h_{ef1})	(h_{ef2})	(h_{ef3})
TFE	TFE05040	Ø5 x 40	✓*	2,99	--	--	3,59	--	--
	TFE05050	Ø5 x 50	✓*		--	--		--	--
	TFE05060	Ø5 x 60	✓*		3,45	4,57		4,14	5,46
	TFE05080	Ø5 x 80	✓*						
	TFE05100	Ø5 x 100	✓*						
	TFE06035	Ø6 x 35	✓	2,99	--	--	3,59	--	--
	TFE06040	Ø6 x 40	✓		--	--		--	--
	TFE06045	Ø6 x 45	✓						
	TFE06050	Ø6 x 50	✓						
	TFE06060	Ø6 x 60	✓		3,45	4,44		4,14	5,33
	TFE06070	Ø6 x 70	✓						
	TFE06080	Ø6 x 80	✓						
	TFE06100	Ø6 x 100	✓						
TFE06120	Ø6 x 120	✓							
TFA	TFA05040	Ø5 x 40	✓*	2,99	--	--	3,59	--	--
	TFA05060	Ø5 x 60	✓*		3,45	4,57		4,14	5,46
	TFA05080	Ø5 x 80	✓*						
	TFA05100	Ø5 x 100	✓*						
	TFA06045	Ø6 x 45	✓	2,99		--	3,59		--
	TFA06050	Ø6 x 50	✓			--			--
	TFA06060	Ø6 x 60	✓						
	TFA06080	Ø6 x 80	✓		3,45	4,44		4,14	5,33
	TFA06100	Ø6 x 100	✓						
	TFA06120	Ø6 x 120	✓						
THT	TFT06040	Ø6 x 40	✓	2,99	--	--	3,59	--	--
	TFT06050	Ø6 x 50	✓		3,45	4,44		4,14	5,33
	TFT06060	Ø6 x 60	✓						
THP	TFP05040	Ø5 x 40	✓*	2,99	--	--	3,59	--	--
	TFP05060	Ø5 x 60	✓*		3,45	4,57		4,14	5,46
	TFP06040	Ø6 x 40	✓	2,99	--	--	3,59	--	--
	TFP06050	Ø6 x 50	✓						
	TFP06060	Ø6 x 60	✓		3,45	4,44		4,14	5,33
	TFP06080	Ø6 x 80	✓						
	TFP06100	Ø6 x 100	✓						
TFF	TFF05035S	Ø5 x 35 (M6)	✓*	2,99	6,22	8,22	3,59	4,14	5,46
	TFF06035	Ø6 x 35 (M8-M10)	✓	2,99			3,59		
	TFF06040	Ø6 x 40 (M8-M10)	✓		3,45	4,44		4,14	5,33
	TFF06055	Ø6 x 55 (M8-M10)	✓						
TFM	TFM06035	Ø6 x 35 (M8)	✓	2,99			3,59		
	TFM06055	Ø6 x 55 (M10)	✓		3,45	4,44		4,14	5,33
TFS	TFS06100	Ø6 x 100 (M8)	✓	2,99			3,59		
	TFS06120	Ø6 x 120 (M8)	✓		3,45	4,44		4,14	5,33

*Ø5 Homologado solamente para uso en hormigón y en losas alveolares prefabricadas para sistemas no-estructurales redundantes

7.3 CARGAS MAXIMAS RECOMENDADAS (APLICACIONES NO ESTRUCTURALES) [kN] (con $\gamma F= 1.4$) [kN]									
Parámetros generales				Losas Alveolares					
Familia	Código	Medida	Homologado ETA	Tracción N_{rec}			Cortadura V_{rec}		
				(h_{ef1})	(h_{ef2})	(h_{ef3})	(h_{ef1})	(h_{ef2})	(h_{ef3})
TFE	TFE05040	Ø5 x 40	✓*	2,14	--	--	2,57	--	--
	TFE05050	Ø5 x 50	✓*		--	--		--	--
	TFE05060	Ø5 x 60	✓*		2,47	3,26		2,96	3,90
	TFE05080	Ø5 x 80	✓*		--	--		--	--
	TFE05100	Ø5 x 100	✓*		--	--		--	--
	TFE06035	Ø6 x 35	✓	2,14	--	--	2,57	--	--
	TFE06040	Ø6 x 40	✓		--	--		--	--
	TFE06045	Ø6 x 45	✓		2,47	3,17		2,96	3,80
	TFE06050	Ø6 x 50	✓		--	--		--	--
	TFE06060	Ø6 x 60	✓		--	--		--	--
	TFE06070	Ø6 x 70	✓		--	--		--	--
	TFE06080	Ø6 x 80	✓		--	--		--	--
	TFE06100	Ø6 x 100	✓		--	--		--	--
TFE06120	Ø6 x 120	✓	--	--	--	--			
TFA	TFA05040	Ø5 x 40	✓*	2,14	--	--	2,57	--	--
	TFA05060	Ø5 x 60	✓*		--	--		--	--
	TFA05080	Ø5 x 80	✓*		2,47	3,26		2,96	3,90
	TFA05100	Ø5 x 100	✓*		--	--		--	--
	TFA06045	Ø6 x 45	✓	2,14	--	--	2,57	--	--
	TFA06050	Ø6 x 50	✓		2,47	3,17		2,96	3,80
	TFA06060	Ø6 x 60	✓		--	--		--	--
	TFA06080	Ø6 x 80	✓		--	--		--	--
	TFA06100	Ø6 x 100	✓		--	--		--	--
TFA06120	Ø6 x 120	✓	--	--	--	--			
TFA06140	Ø6 x 140	✓	--	--	--	--			
THT	TFT06040	Ø6 x 40	✓	2,14	--	--	2,57	--	--
	TFT06050	Ø6 x 50	✓		2,47	3,17		2,96	3,80
	TFT06060	Ø6 x 60	✓		--	--		--	--
THP	TFP05040	Ø5 x 40	✓*	2,14	--	--	2,57	--	--
	TFP05060	Ø5 x 60	✓*		2,47	3,26		2,96	3,90
	TFP06040	Ø6 x 40	✓	2,14	--	--	2,57	--	--
	TFP06050	Ø6 x 50	✓		2,47	3,17		2,96	3,80
	TFP06060	Ø6 x 60	✓		--	--		--	--
	TFP06080	Ø6 x 80	✓		--	--		--	--
	TFP06100	Ø6 x 100	✓		--	--		--	--
TFF	TFF05035S	Ø5 x 35 (M6)	✓*	2,14	2,47	3,26	2,57	2,96	3,90
	TFF06035	Ø6 x 35 (M8-M10)	✓	2,14	2,47	3,17	2,57	2,96	3,80
	TFF06040	Ø6 x 40 (M8-M10)	✓						
	TFF06055	Ø6 x 55 (M8-M10)	✓						
TFM	TFM06035	Ø6 x 35 (M8)	✓	2,14	2,47	3,17	2,57	2,96	3,80
	TFM06055	Ø6 x 55 (M10)	✓						
TFS	TFS06100	Ø6 x 100 (M8)	✓	2,14	2,47	3,17	2,57	2,96	3,80
	TFS06120	Ø6 x 120 (M8)	✓						

*Ø5 Homologado solamente para uso en hormigón y en losas alveolares prefabricadas para sistemas no-estructurales redundantes

8. DOCUMENTACION OFICIAL

A través de nuestro departamento comercial o de nuestra página web www.indexfix.com puede obtener los siguientes documentos:

- Homologación europea ETA 20/0046 para instalación en hormigón fisurado y no fisurado según guía EAD 330232-01-0601, opción 1, de Ø6 a Ø18.
- Homologación europea ETA 20/0494 para uso en hormigón y en losas alveolares prefabricadas para sistemas no-estructurales redundantes según guía EAD 330747-00-0601 de Ø5 a Ø6.
- Declaración de prestaciones DoP THE.
- Certificado VdS CEA 4001:2021-01(07) *Guidelines for sprinklers systems. Planning and installation for applications of water extinguishing systems on concrete elements* de Ø8 a Ø18.
- Disponible para el programa de cálculo de anclajes INDEXcal.