

GPSSA, GPSS series

Ordering code

GPSS 6 01 A □

① ② ③ ④ ⑤

① Model	② Port size	③ Thread connection		④ Control method	⑤ Standard color	
GPSS: Universal speed controller(G thread)	4: Φ4mm 6: Φ6mm 8: Φ8mm 10: Φ10mm 12: Φ12mm	Thread	Adaptable port size	A: Meter-out Controlled flow Free flow B: Meter-in Free flow Controlled flow	Standard color	Specification
		M5: M5X0.8	Φ4	Handle marking "A" Handle marking "B"	Blank: Gray D: Black	Release button: Gray Body: Gray Release button: Black Body: Black
		01: G1/8 02: G1/4 03: G3/8 04: G1/2	Φ4, Φ6 Φ8, Φ10 Φ12			

GPSSA 6 □

① ② ③

① Model	② Port size	③ Standard color	
GPSSA: Straight speed controller	4: Φ4mm 6: Φ6mm 8: Φ8mm 10: Φ10mm 12: Φ12mm	Standard color	Specification
		Blank: Gray D: Black	Release button: Gray Body: Gray Release button: Black Body: Black

Product feature

- The silencer is small size, and light weight with small installation space.
- Excellent flow characteristics, high sensitivity and easy to adjust.
- The silencer brass body adopts a special nickel-plating process, which has good corrosion resistance and anti-pollution property.
- Anti-drop structure is designed on the regulating rod.
- The sealant being coated on threaded portion can ensure no leakage of the threaded connection part.
- The inserting direction of universal speed controller can be adjusted in 360°.

Specification

Operating pressure range	0~10kgf/cm ² (0~1.0MPa)
Negative pressure	-750mmHg(10Torr)
Proof pressure	1.5MPa
Ambient and fluid temperature (°C)	-20~70
Applicable tubing	Soft nylon or polyurethane
Color	Gray/black

Table for interface port and tube O.D.

Product series	Thread type	Port size				
		Φ4	Φ6	Φ8	Φ10	Φ12
GPSSA	-	●	●	●	●	●
	M5	●				
	G1/8		●	●		
GPSS	G1/4		●	●	●	
	G3/8				●	●
	G1/2					●

Symbol

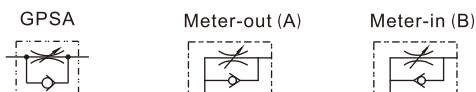

Inner structure

GPSSA Series

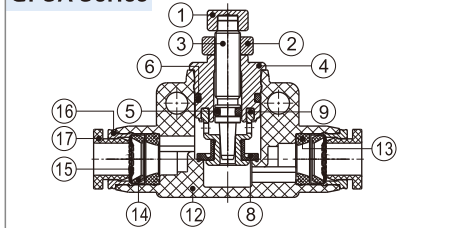

GPSS Series

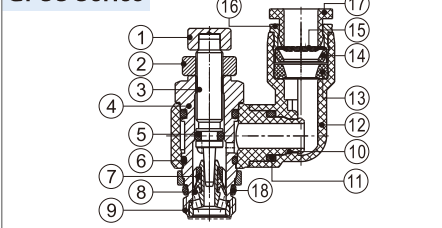

NO.	Name	Material	NO.	Name	Material	NO.	Name	Material
1	Adjusting cap	Aluminum alloy	7	Holder	PBT	13	O-ring	NBR
2	Locking cap	Aluminum alloy	8	O-ring	NBR	14	Locating seat	POM
3	Throttling column	Brass	9	Throttling sleeve	Aluminum alloy/Brass	15	Spring gasket	Stainless steel
4	Throttling body	Brass	10	Plastic body	PBT	16	Locating ring	Aluminum alloy
5	O-ring	NBR	11	O-ring	NBR	17	Plastic interface	POM
6	O-ring	NBR	12	Plastic body	PBT	18	O-ring	NBR

GPSSA, GPSS series

Dimensions

GPSS Series

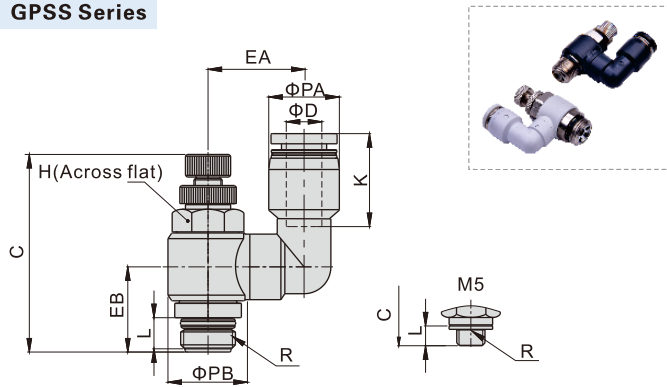

GPSSA Series

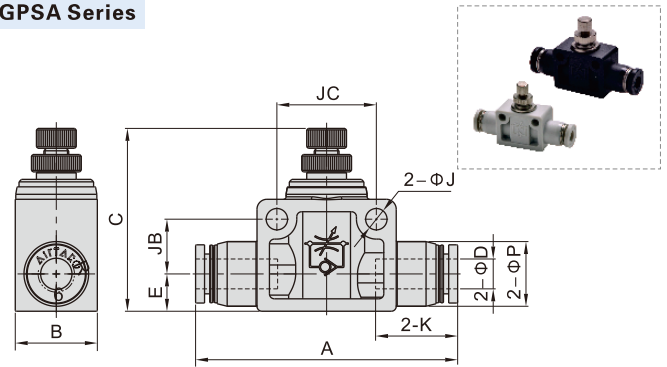

Model\Item [Note1]	ΦD	R	ΦPA	ΦPB	L	C		K	EA	EB	H	Weight (g)	PCS/bag
						max	min						
GPSS4M5□	4	M5×0.8	9	10	3.5	30	27.5	14	12.5	9.5	8	8.1	2
GPSS601□	6	G1/8	12.5	14	5.5	41.5	35	17	17	15	11	19	2
GPSS602□		G1/4	12.5	18	6.5	47.5	41	17	19	17.5	14	34.7	2
GPSS801□	8	G1/8	15	14	5.5	41.5	35	18.5	17	15	11	20.2	2
GPSS802□		G1/4	15	18	6.5	47.5	41	18.5	19	17.5	14	39.8	2
GPSS1002□	10	G1/4	18	18	6.5	47.5	41	21	20.5	17.5	14	37.2	2
GPSS1003□		G3/8	18	22.5	7	52.5	45.5	21	24	20	19	66	2
GPSS1203□		G3/8	21	22.5	7	52.5	45.5	23	25.5	20	19	69.2	2
GPSS1204□	12	G1/2	21	28	8.5	58.5	51.5	23	28	25	24	105.8	2

[Note1] "□" stands for A or B. A indicates meter-out type while B indicates meter-in type. The two types are with the same overall dimension.

Model\Item	ΦD	A	B	C		ΦP	E	K	ΦJ	JB	JC	Weight (g)	PCS/bag
				max	min								
GPSSA4	4	41	11	29	26.5	9.5	7	14	3.2	6	14	7.85	2
GPSSA6	6	52.5	16.5	43.5	36.5	13	7.5	16.5	4.3	11	20	18.3	2
GPSSA8	8	59.5	16.5	47	40	15	8.5	18.5	4.3	11	22	23.5	2
GPSSA10	10	69	21	53.5	46.5	18	10.5	21	4.3	14.5	26	42.4	2
GPSSA12	12	78.5	26	58.5	51	21.5	12	23	4.3	17.5	32	67.5	2

GPSSA, GPSS series

Flowrate characteristic

Controlled flow rate

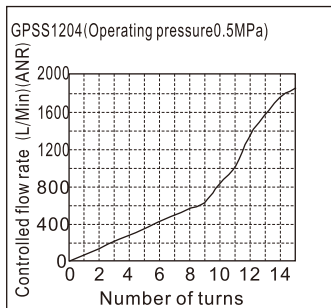
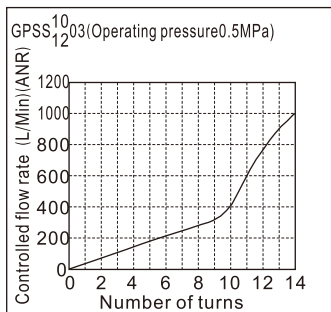
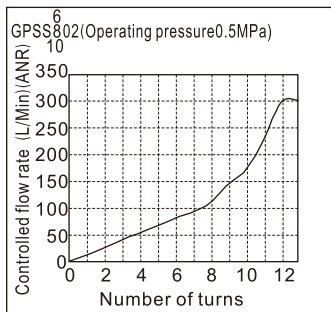
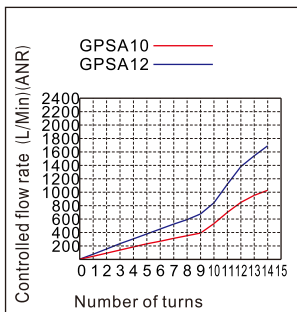
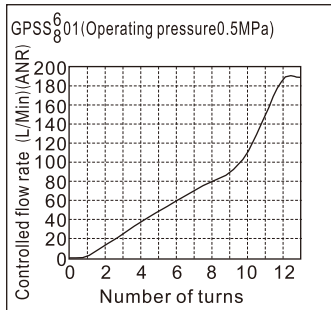
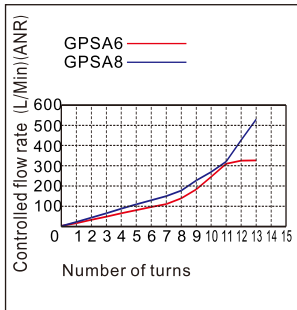
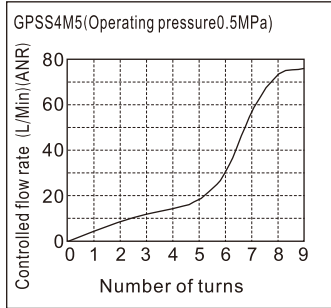
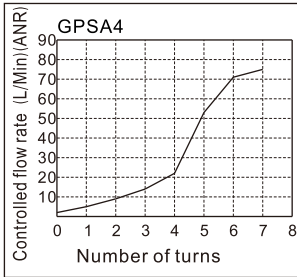

Free flow rate

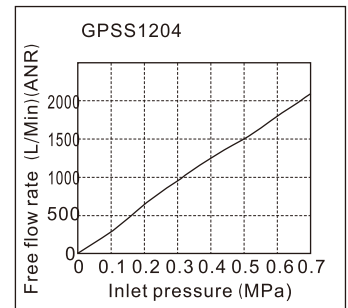
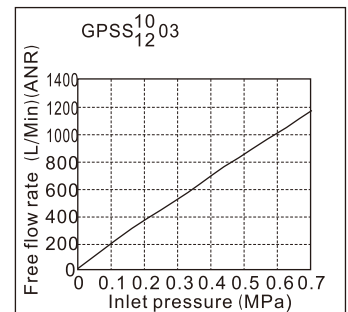
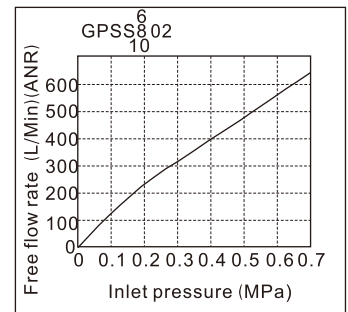
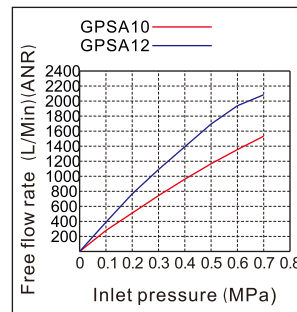
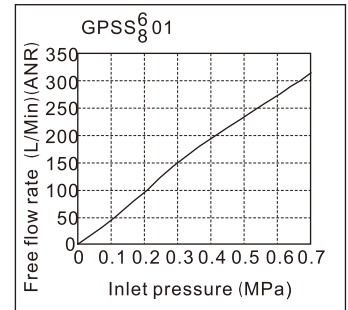
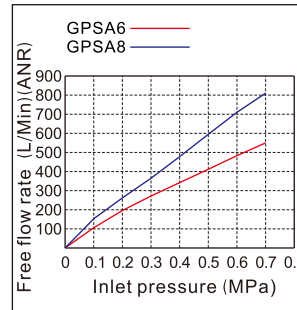
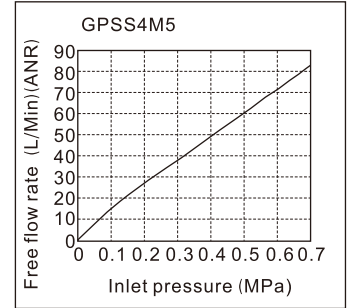
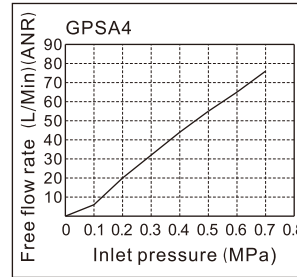

Selection, Installation and Operation

Selection

1. The speed controller has meter-out type and meter-in type:

	Working principle	Product identification
<p>Controlled flow Free flow</p>	A: Meter-out 1. The air flow is controlled from the threaded end to tubing connection end. 2. The air flow is free from the tubing connection end to the threaded end.	Handle marking "A"
<p>Free flow Controlled flow</p>	B: Meter-in 1. The air flow is free from the threaded end to tubing connection end. 2. The air flow is controlled from the tubing connection end to the threaded end.	Handle marking "B"

2. Select the different control method according to the actual requirement. The meter-out type is the first priority.

2.1. The application example of the meter-out speed controller	2.2. The application example of the meter-in speed controller
<p>Solenoid valve Double acting cylinder</p> <p>Meter-out speed controller</p>	<p>Solenoid valve Single acting cylinder</p> <p>Meter-in speed controller</p>

Installation

1. Installation and removal of tubing:

1.1. Installation of tubing

Grasp the tubing and slowly push it into the fitting until it comes to a stop. The tubing will be locked by the spring gasket.

1.2. Removal of tubing

Push the release button to open the spring gasket so that the tubing can be released.

Note: When remove the tubing, make sure the pressure in the tubing is Zero.

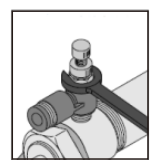
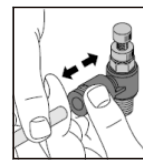
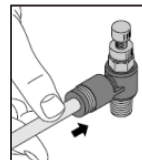

2. Mounting of the speed controller

Mount the speed controller into the inlet and outlet port of the cylinder with a wrench.

Note: Please refer to the fittings for the tightening torque and thread screw-in depth.

Operation

1. Adjustment of the cylinder speed

1.1. Make sure the speed controller is turned off before applying air pressure. The cylinder may fly out due to the high speed if the air is inlet when the speed controller is turned on.

1.2. Adjust the speed by opening the needle slowly from the fully closed state. When a needle valve is turned clockwise, the air flow through is reduced and the actuator speed decreases. When a needle valve is turned counter-clockwise, the air flow through is increased and the actuator speed increases.

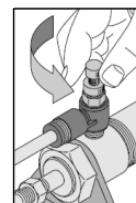
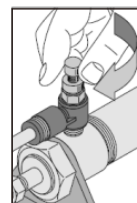

2. Operation of the speed controller

2.1. Do not use tools such as pliers to rotate the handle. Do not apply excessive force or shock when the needle is at the place of top or bottom. It can cause damage or air leakage.

2.2. A certain amount of leakage is allowed in the closed state of the speed controller. It is not designed for the use as stop valve with zero air leakage.