



Compendium of DMS Series

Two types of sensors

Solid State Sensor (Blue)	Waterproof type of Solid State Sensor (Yellow)
---------------------------	--

Bending resistance

SR: bending resistance

Vibration resistance, impact resistance

Four types of cross section

G Type	
H Type	
E Type	
J Type	

Two kinds of accessories

DMSG, Each size of the cylinder has its corresponding accessory.

DMSG	F-MQ
	F-SC SH

DMS Specifications

Item	DMS		
	2-wire	NPN	PNP
Model			
Power supply voltage	10V ~ 28V DC	5V ~ 30V DC	
Switching current	2.5mA ~ 100mA	30V/200mA Max.	
Contact capacity	2.8W Max.	6.0W Max.	
Current consumption	3mA Max.	5mA Max.	
Internal voltage drop	2.7V Max.	0.7V Max.	
Leakage current	0.05mA Max.	0.01mA Max.	
Switching frequency	1000Hz		
Impact resistance	50G		
Circuit protection	Reverse polarity protection Surge protection		
Operating Temp.	-10°C ~ 70°C		
Enclosure	IP64/IP68		
Standard	CE marking, RoHS		

Ordering code for DMS

DMS G - □ 020 - □

① ② ③ ④ ⑤

G

H

E

J

M08

M12

		DMS : Solid State Sensor			
		G	H	E	J
① Model					
② Specifications					
③ Output type		Blank: 2 wire	N : NPN		P : PNP
④ Lead wire length	Wire type	020: 2m 030: 3m 050: 5m 100: 10m			
	Plug connector type	M08:0.5m with M8 plug connector	M12:0.5m with M12 plug connector		
		M08010:1m with M8 plug connector	M12010:1m with M12 plug connector		
		M08020:2m with M8 plug connector	M12020:2m with M12 plug connector		
		M08030:3m with M8 plug connector	M12030:3m with M12 plug connector		
⑤ Additional specification		Blank: General type		W: Waterproof type IP68 [note 1]	

[Note 1] There is no waterproof type for M08/M12 & J.

The sockets of M08 and M12 need additional order. Please check on page 361.





Compendium of CMS Series

Two types of sensors

Reed Sensor (Blue)	Heat resistant of Reed Sensor (Red)
--------------------	-------------------------------------

Bending resistance

Four types of cross section

G Type	
H Type	
E Type	
J Type	

Two kinds of accessories

CMSG, Each size of the cylinder has its corresponding accessory.

CMSG	F-MQ □
	F-SC □ SH

CMS Specifications

Item	CMS	
	General	Heat resistant
Model	General	Heat resistant
Power supply voltage	5V ~ 240V AC/DC	
Switching current	100mA	
Contact capacity	10W Max.	
Current consumption	N/A	
Internal voltage drop	2.5V Max. @100mA DC	N/A
Leakage current	N/A	
Switching frequency	200Hz	
Impact resistance	50G	
Circuit protection	N/A	
Operating Temp.	-10°C ~ 70°C	-10°C ~ 125°C
Enclosure	IP64	
Standard	CE marking, RoHS	

Ordering code for CMS

CMS G-020-□

① ② ③ ④

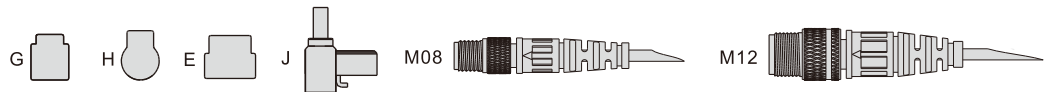

① Model		CMS: Reed Sensor			
② Specifications		G	H	E	J
③ Lead wire length	Wire type	020: 2m	030: 3m	050: 5m	100: 10m
	Plug connector type	M08: 0.5m with M8 plug connector M08010: 1m with M8 plug connector M08020: 2m with M8 plug connector M08030: 3m with M8 plug connector		M12: 0.5m with M12 plug connector M12010: 1m with M12 plug connector M12020: 2m with M12 plug connector M12030: 3m with M12 plug connector	
④ Additional specification		Blank: General type		H: Heat resistant [note 1]	

[Note 1] There is no heat resistant type for M08 & M12.
The sockets of M08 and M12 need additional order. Please check on page 361.



Ordering code for accessories

F - MQ □ Cylinder Accessory



① ② ③

① Category	F : Accessory								
② Model	MQ : Cylinder Accessory								
③ Cylinder	Aluminum alloy			Aluminum alloy (Thick type)			Stainless steel		
	Code	For series	For bore size	Code	For series	For bore size	Code	For series	For bore size
	A20: Φ20mm	MCK	Φ20	A32T: Φ32mm	TWG	Φ32	S06: Φ6mm	PB/PBR MI MF MG MA/MAC	Φ6
	A25: Φ25mm		Φ25	A40T: Φ40mm		Φ40	S08: Φ8mm		Φ8
	A32: Φ32mm	MBL	Φ32	A50T: Φ50mm	Φ50	S10: Φ10mm	Φ10		
	A40: Φ40mm		Φ40	S12: Φ12mm	Φ12				
	A50: Φ50mm	Φ50	S16: Φ16mm	Φ16					
	A63: Φ63mm	Φ63	S20: Φ20mm	Φ20					
	A80: Φ80mm	Φ80	S25: Φ25mm	Φ25					
			S32: Φ32mm	Φ32					
		S40: Φ40mm	Φ40						
		S50: Φ50mm	Φ50						
		S63: Φ63mm	Φ63						

F - SC □ SH Tie Rod Cylinder Accessory



① ② ③ ④

① Category	F : Accessory		
② Model	SC : Tie Rod Cylinder Accessory		
③ Cylinder	Code	For series	For bore size
	32	SC SGC	Φ32, Φ40
	50		Φ50
	63		Φ63
	80		Φ80, Φ100
	125		Φ125
	160		Φ160, Φ200
250	Φ250		
④ Attached			

Dimensions

G Type

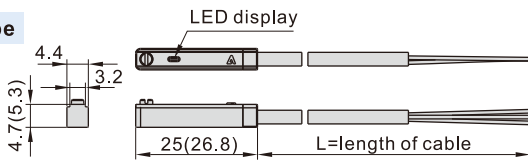

Note: a number in the bracket is the dimension of CMMSG.

E Type

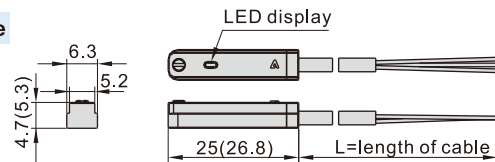

Note: a number in the bracket is the dimension of CMSE.

H Type

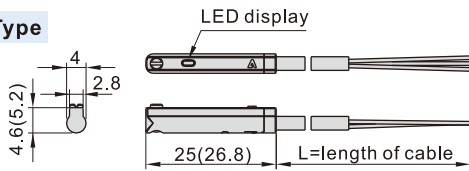

Note: a number in the bracket is the dimension of CMH.

J Type

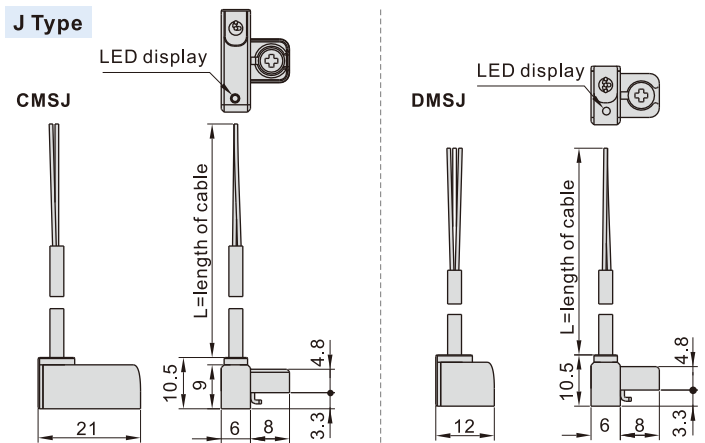

length of cable specification	length of cable(L)
020 Type	2000mm
030 Type	3000mm
050 Type	5000mm

Connection method

2 wire, reed sensor connection

1.General connection

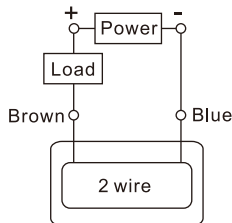

2.Series connection(And)

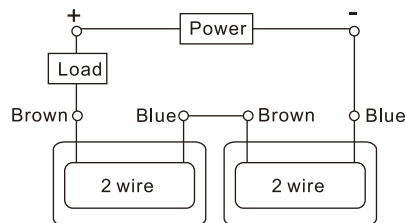

3.Parallel connection(OR)

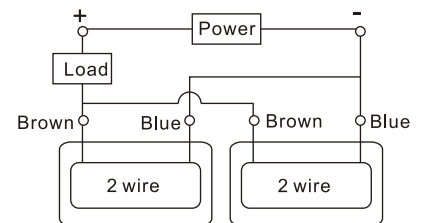

3 wire, solid state NPN connection

1.General connection

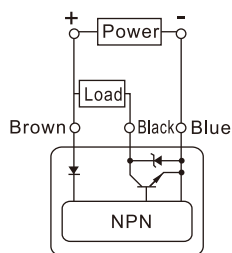

Note: The indicator lights will light up when both auto switches are turned NO.

2.Series connection(And)

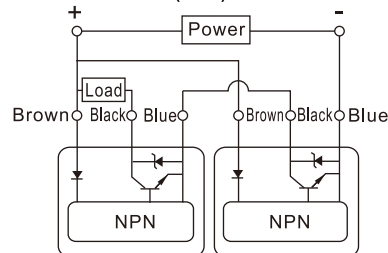

3.Parallel connection(OR)

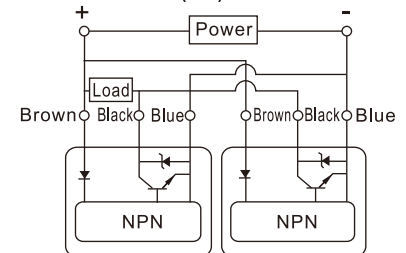

3 wire, solid state PNP connection

1.General connection

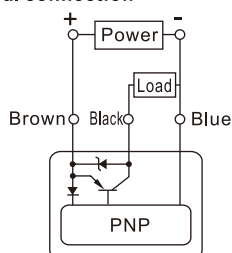

Note: The indicator lights will light up when both auto switches are turned NO.

2.Series connection(And)

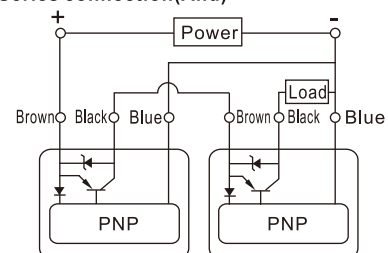

3.Parallel connection(OR)

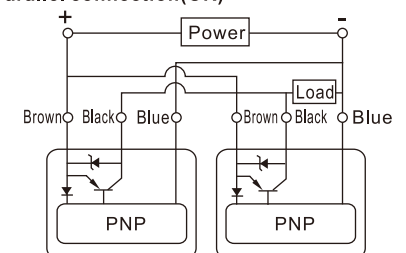

The selection of sensor

DMSG	CMSG	HFKL				MCK				ACQ/TACQ								QCK														
		10	16	20	25	25	32	40	50	63	80	12	16	20	25	32	40	50	63	80	100	125	140	160	12	16	20	25	32	40	50	63
		●	●	●	●	●	●	●	●	●	●	●	●	●	●	●	●	●	●	●	●	●	●	●	●	●	●	●	●	●	●	●
		HFK				TCL/TCM								HFZ				HFY														
		10	16	20	25	32	40	6	10	12	16	20	25	32	40	50	63	80	100	6	10	16	20	25	32	40	6	10	16	20	25	32
		●	●	●	●	●			●	●	●	●	●	●	●	●	●	●	●			●	●	●	●	●		●	●	●	●	●
		TR				HFP				MD/MK																						
		6	10	16	20	25	32	10	16	20	25	32	6	10	16	20	25	32														
		●	●	●	●	●	●	●	●	●	●	●	●	●	●	●	●	●														



		Stainless steel																						
		PB/PBR				MI		MI/TMI		MI		MF				MG								
		6	8	10	12	16	8	10	12	16	20	25	32	40	20	25	32	40	20	25	32	40	50	63
		●	●	●	●	●	●	●	●	●	●	●	●	●	●	●	●	●	●	●	●	●	●	●
		Aluminum alloy										It needs an accessory to mount a sense on a cylinder												
		MBL					MCK																	
		20	25	32	40	50	63	25	32	40	50											63	80	
		●	●	●	●	●	●	●	●	●	●	●	●											
		SGC				It needs an accessory to mount a sense on a cylinder																		
		125	160	200	250																			
		●	●	●	●																			

DMSJ	CMSJ	ACQ/TACQ					QCK				QDK				
		32	40	50	63	80	100	32	40	50	63	20	25	32	40
		●	●	●	●	●	●	●	●	●	●	●	●	●	●

DMSH	CMSH	ACQ/TACQ			TC		HFZ				HFY		HFP		HFR				HFC				HFT											
		125	140	160	6	10	6	10	16	20	25	32	40	6	32	10	16	20	25	32	16	20	25	32	40	50	63	10	16	20	25	32		
		●	●	●	●	●	●	●	●	●	●	●	●	●	●	●	●	●	●	●	●	●	●	●	●	●	●	●	●	●	●	●		
		QDK			HLQ/HLQL				HLS/HLSL				MU				HLH		MPG															
		20	25	32	40	6	8	12	16	20	25	6	8	12	16	20	25	6	8	10	12	16	20	6	8	10	12	16						
		●	●	●	●	●	●	●	●	●	●	●	●	●	●	●	●	●	●	●	●	●	●	●	●	●	●	●	●					
		HRQ				HFK				HLF		HGS		RMH		HFD																		
		2	3	7	10	20	30	50	70	100	200	10	16	20	25	32	40	8	12	16	20	6	8	10	12	10	16	20	25	8	12	16	20	25
		●	●	●	●	●	●	●	●	●	●	●	●	●	●	●	●	●	●	●	●	●	●	●	●	●	●	●	●	●	●	●	●	●
		HFKL			HFCQ																													
		10	16	20	25	16	20	25	32	40	50	63																						
		●	●	●	●	●	●	●	●	●	●																							

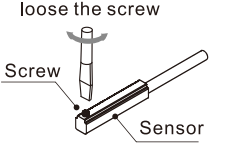
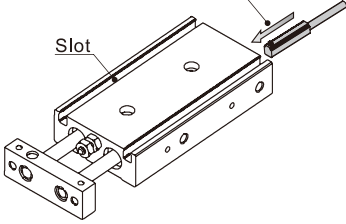
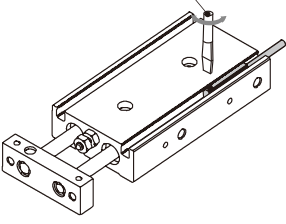
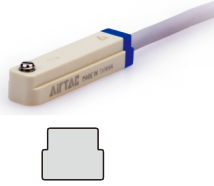
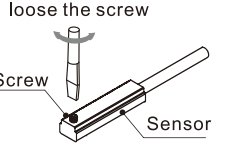
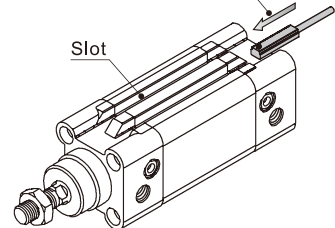
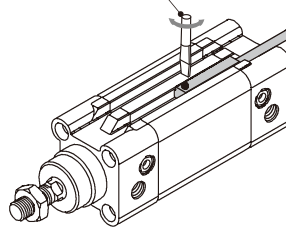

DMSE	CMSE	SE/BSE					SAI/TSAI					SAI		ACE															
		32	40	50	63	80	100	125	32	40	50	63	80	100	125	160	200	12	16	20	25	32	40	50	63	80	100	125	
		●	●	●	●	●	●	●	●	●	●	●	●	●	●	●	●	●	●	●	●	●	●	●	●	●	●	●	●

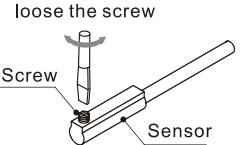
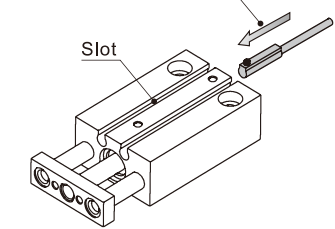
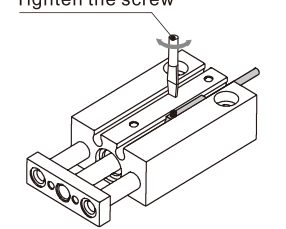
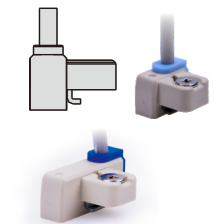
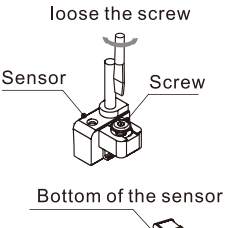
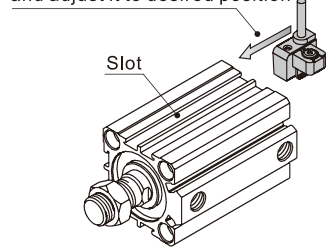
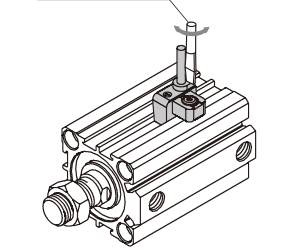
Installation

Sensor model	Procedure		
DMSG/CMSG 	1  loose the screw Screw Sensor The screw should NOT protrude the bottom Bottom of the sensor	2  Insert the sensor into the slot and adjust it to desired position Slot	3  Tighten the screw
DMSE/CMSE 	1  loose the screw Screw Sensor The screw should NOT protrude the bottom Bottom of the sensor	2  Insert the sensor into the slot and adjust it to desired position Slot	3  Tighten the screw
DMSH/CMSH 	1  loose the screw Screw Sensor The screw should NOT protrude the bottom Bottom of the sensor	2  Insert the sensor into the slot and adjust it to desired position Slot	3  Tighten the screw
DMSJ/CMSJ 	1  loose the screw Sensor Screw Bottom of the sensor Adjust the metal part till the lateral shape can fit the slot of the cylinder	2  Insert the sensor into the slot and adjust it to desired position Slot	3  Tighten the screw



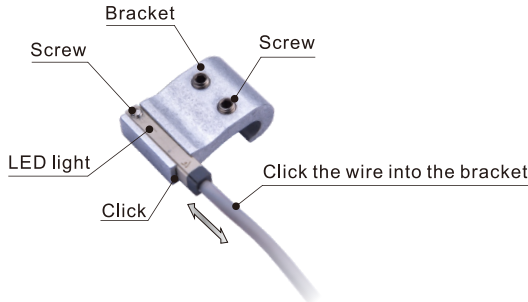
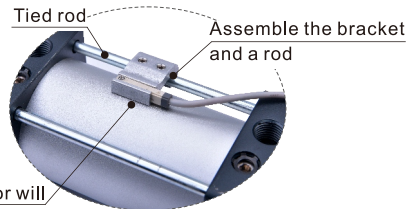

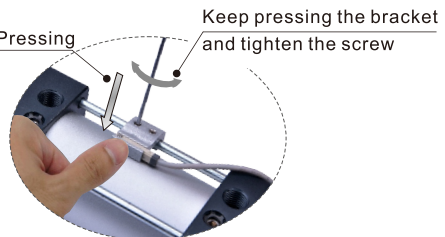
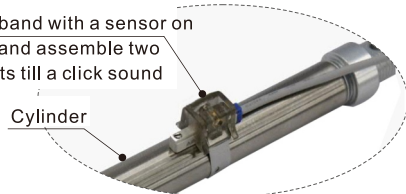
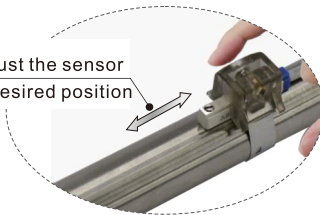
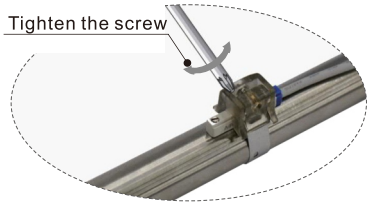

Sensor

DMS、CMS Series

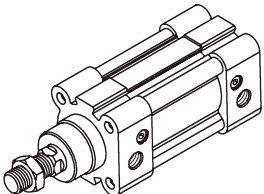
Sensor model	Procedure	
DMSG+(F-SC□SH) CMSG+(F-SC□SH) 	1	 <p>Bracket</p> <p>Screw</p> <p>Screw</p> <p>LED light</p> <p>Click the wire into the bracket</p> <p>Click</p>
	2	 <p>Tied rod</p> <p>Assemble the bracket and a rod</p> <p>The sensor will attach to the surface</p>
	3	 <p>Adjust the sensor to desired position</p>
	4	 <p>Pressing</p> <p>Keep pressing the bracket and tighten the screw</p>
DMSG+(F-MQ□) CMSG+(F-MQ□) 	1	 <p>Screw (sensor)</p> <p>Screw (accessory)</p> <p>Groove for sensor</p> <p>Band</p> <p>Insert the sensor into the groove</p>
	2	 <p>Tie up the band with a sensor on a cylinder and assemble two plastic parts till a click sound</p> <p>Cylinder</p>
	3	 <p>Adjust the sensor to desired position</p>
	4	 <p>Tighten the screw</p>

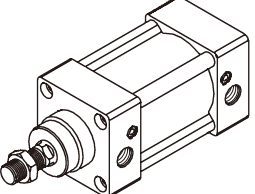
Sensor for "米" shape cylinder

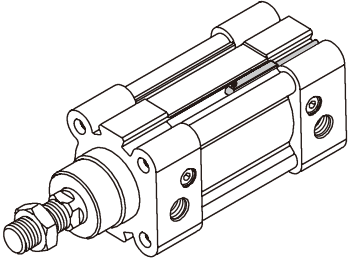
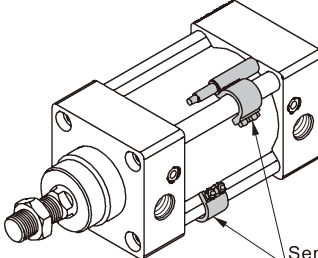
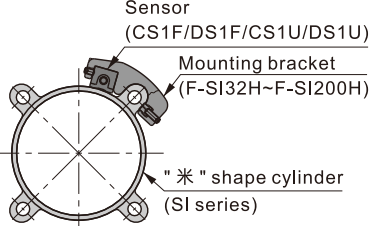
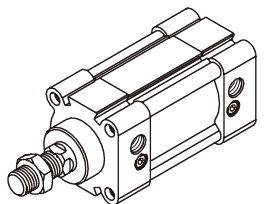
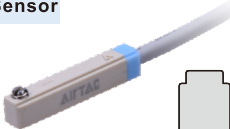
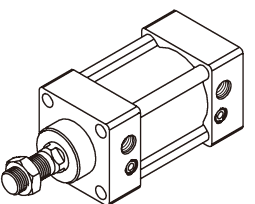
SAI, SAU series will substitute for SI, SU series. And the corresponding sensors have some adjustments as the chart below.

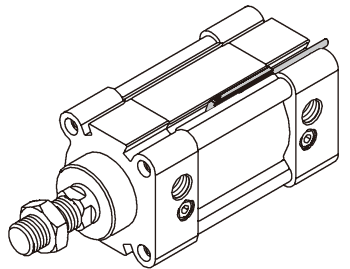
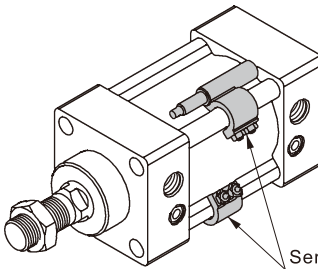
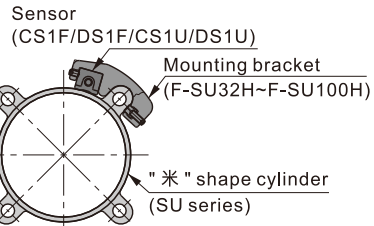
New type(SAI)		Previous type(SI)	
Cylinder and accessory	<p>Cylinder</p>  <p>Sensor</p>  <p>CMSE \ DMSE</p>	Cylinder and accessory	<p>Cylinder</p>  <p>Sensor</p>  <p>CS1B1 / DS1B1 CS1B2 / DS1B2 CS1B3 / DS1B3 CS1B4 / DS1B4 CS1B5 / DS1B5 CS1B6 / DS1B6 CS1B7 / DS1B7</p>  <p>CS1F/DS1F/CS1U/DS1U + F-SI32H/F-SI40H F-SI50H/F-SI63H F-SI80H/F-SI100H F-SI125H/F-SI160H F-SI200H</p>
Installation		Installation	  <p>Sensor (CS1F/DS1F/CS1U/DS1U) Mounting bracket (F-SI32H~F-SI200H) "米" shape cylinder (SI series)</p> <p>Sensor (CS1B1~B7/DS1B1~B7)</p>
New type(SAU)		Previous type(SU)	
Cylinder and accessory	<p>Cylinder</p>  <p>Sensor</p>  <p>CMSG \ DMSG</p>	Cylinder and accessory	<p>Cylinder</p>  <p>Sensor</p>  <p>CS1B1 / DS1B1 CS1B2 / DS1B2 CS1B3 / DS1B3 CS1B4 / DS1B4</p>  <p>CS1F/DS1F/CS1U/DS1U + F-SU32H/F-SU40H F-SU50H/F-SU63H F-SU80H/F-SU100H</p>
Installation		Installation	  <p>Sensor (CS1F/DS1F/CS1U/DS1U) Mounting bracket (F-SU32H~F-SU100H) "米" shape cylinder (SU series)</p> <p>Sensor (CS1B1~B4/DS1B1~B4)</p>

Socket

Ordering code

F - EC M08 B 020 - □

① ② ③ ④ ⑤ ⑥



① Category code	F : Accessory			
② Specification code	EC : Connect wire line			
③ Socket type	M08:M8 socket	M12:M12 socket		
④ Wire type	B: 2-wire type	C:3-wire type		
⑤ Wire length	020: 2 meters	030:3meters	050:5meters	100:10meters
⑥ Add code	Blank: General type			

Appearance

M8 socket

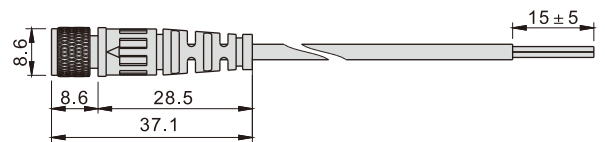
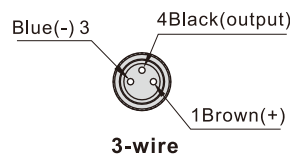
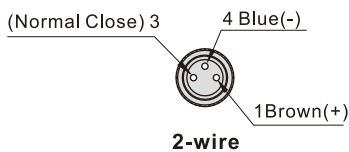

M12 socket

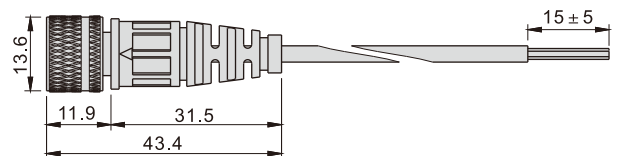
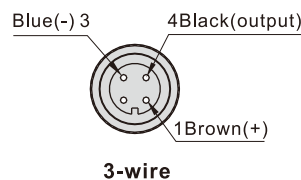
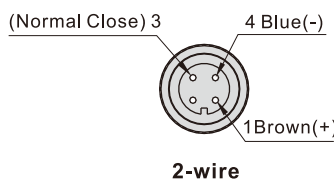

Instruction

- Sensor shall not fall down or bear great impact when it is installed.
- The wire of the Sensor shall not move with the action of cylinder.
- Clamping torque shall be within the allowable scope when the Sensor is installed(0.15~0.2Nm).
- Sensor shall be installed in the middle position of the action scope.
- Sensor wiring:
 - The wire is unable to bear repetitive torsion and tension. Please wire an external load before switch the power on.
 - No poor insulation in wire.
 - Do not wire with power line, high voltage line or use one wiring pipe.
 - Please wire the circuit correctly base on the circuit diagram.
- Execute scheduled maintenance by the following guidelines:
 - Make sure the sensor is firmly fixed.
 - Make sure the wire is intact.
 - Make sure that LED indicate the movement of cylinder correctly.
- Application of environment:
 - It is Not allow to use the sensor in the environment with explosive gas.
 - Magnetic sensor shall not be used in the environment with external magnetism.
 - Magnetic sensor shall not be used in the environment that is always eroded by water.
 - Magnetic sensor shall not be used in the environment with oil moisture or chemical substance.
 - Magnetic sensor shall not be used in the environment with periodically changing temperature.
 - Magnetic sensor shall not be used in the environment with excessively great impact.
 - Magnetic sensor shall not be used in the environment with sources of electrical pulse.
 - Avoid the environment with accumulated iron power and dense magnetic objects.